

AirScan™ iR

Refrigerant Sensor for
Commercial Applications

Instruction and
Installation Manual

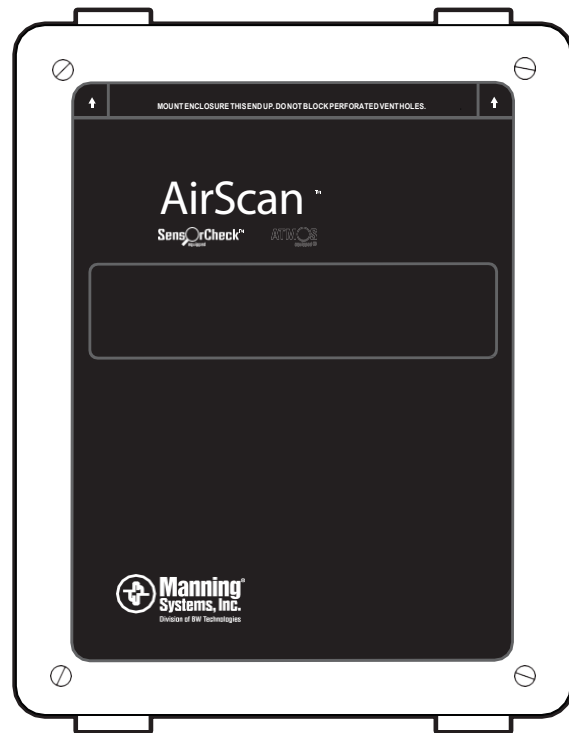

405 Barclay Boulevard
Lincolnshire, Illinois 60069
Tel: +1 847 955 8200
Toll free: +1 800 538 0363
Fax: +1 847 955 8208

ha_manning@honeywell.com
www.honeywellanalytics.com
www.manningsystems.com
18908 AirScan-iR-comm 05/2016 REVD

Contents

Serial number:

Section	Title	Page
1 Sensor Description	System Specifications and Sensor Specifications	4
2 Installation	A Locating the Sensor	5
	Figure 1: Mounting Dimensions for the AirScan™iR	5
	B Wiring	6
	Figure 2: Wiring Diagram for AirScan™iR	6
3 Operation	A Start-up Procedure	7
	Figure 3: Required LED Status at Start-up	7
	B Pushbutton Operation, LED Indicators, Adjustment Pots and Test Points	8
	Figure 4: Board Component Layout	8
	Figure 5: LED Layout	8
	LED Indicators and Blink Sequence	9
	Figure 6: LED Blink Sequence	9
	Figure 7: LED Indicator Summary	10
	Normal Run Modes	10
	4/20 mA Loop Test Mode	10
	Calibration Mode	10
	Fault Indicator Error Sequences	11
	C Modes of Operation	12
	Normal Run Modes	12
	4/20 mA Loop Modes	13
	Calibration / Programming Modes	14
	D Calibration	15
	Figure 8: Board Component Layout	15
	4/20 mA Output Calibration	17
	Zero Calibration	17
	Figure 9: Board Component Layout	18
	Span Calibration	18
	E Diagnostic Procedures	19
	Simple Zero Test	19
	4/20 mA Output Loop Integrity Check	19
	F Troubleshooting	21
	Electrical Interference	21
	Figure 10: Troubleshooting the AirScan™iR	21
	Sensor On-Board Diagnostic System	21
	Error on 4/20 mA Output	22
	Sensor Output at 0 mA	22
	Sensor Output at .5 mA	22
	Gas Concentration Indicated with No Refrigerant Present	22
	IR Source Failure	22
4 Maintenance		23
5 Replacement Parts		23
6 Limited Warranty		24

Introduction

This manual has been prepared to help in the use and installation of the Manning Systems AirScan™iR (Infrared Refrigerants) Sensor. This manual will convey the operating principles of the sensor, ensure proper installation, and demonstrate start-up and routine maintenance procedures.

This manual must be carefully followed by all individuals who have or will have the responsibility for using or servicing the AirScan™iR Sensor. Warranties made by Manning Systems, Inc. with respect to this equipment will be voided if the equipment is not used and serviced in accordance with the instructions in this manual. If in doubt about a procedure, please contact Manning Systems, Inc. before proceeding.

1 Sensor Description

Gas detection by the infrared method is based on the principle that most gases absorb infrared energy at a characteristic frequency. In this instrument, a broad band infrared source emits energy which is then band-pass filtered to produce a narrow range of frequencies characteristic of the refrigerants' (CFC/HCFC/HFC) absorption spectra. Any refrigerant in the gas sample cell selectively absorbs energy reaching the detector. This reduction in energy is detected, amplified and sent to the signal processing portion of the system.

The Manning Systems AirScan™iR Sensor line is a three-wire, 4/20 mA sensor for two bands of refrigerants available in a range of 0–3,000 ppm, but can be adjusted for lower ranges, if required. The low-band or R-404a infrared sensor reacts to R-123, R-134a, R-404a and R-507. The high-band or R-22 AirScan™iR sensor reacts to R-22.

Its solid, high-mass metal bench provides structural and thermal stability, greater immunity to vibration, as well as superior EMI/RFI shielding of the detector and source. Internal compensation for environmental changes allows the sensor to automatically adapt to fluctuating temperature and humidity conditions. The unit exhibits extremely high reliability with no moving parts.

Every two seconds SensorCheck™ technology monitors the AirScan™iR source and ensures that the dual channels are functioning properly. A notification signal will be transmitted if any of several performance parameters is not met.

Monitoring equipment must be configured to indicate a fault if the signal is less than 1.5 mA. All signals over 20 mA must be considered a high gas concentration.

Manning Systems infrared sensors are normally long-lived (5 years plus), unless physically damaged or wetted with water or other liquid.

System Specifications

Electrical Power: 24 Volts DC regulated, 1.0 amp.

Output: Linear 4/20 mA output into a load resistor of 500 ohms maximum

Cable Length to Sensor: 1,000 feet maximum

Cable Recommendation: Three conductor, stranded, shielded cable with drain wire, all enclosed in a vinyl jacket. For cable runs up to 200 feet use, #18 AWG (Belden #8770 or equivalent). For cable runs up to 1,000 feet, use #16 AWG (Belden #8618 or equivalent).

Unit Enclosure: NEMA 4, gasketed, molded fiberglass reinforced polyester. Non-painted, non-rusting construction appropriate for food areas. UL 508 listed, CSA certified for use with industrial control equipment.

NOTE: The standard AirScan™iR is for use in non-classified areas only.

Sensor Specifications

Type: CFC/HCFC/HFC selective infrared gas sensor/transmitter AirScan™iR

Method of Detection: Dual channel infrared energy absorption (N.D.I.R. Non-dispersive Infrared)

Gases Monitored: Low-Band (R-404a, R-507, R-134a, and R-123), High-Band (R-22)

Range Available: 0–3,000 ppm (can be rescaled to 0–1,000 ppm, or 0–500 ppm if required)

SensorCheck™ Features: Dual channel functionality test, source strength evaluation, incoming voltage monitor, IR source integrity check, operating temperature monitor, “zero” down drift monitor, and internal circuitry check.

Accuracy: ± 3% of full scale

Repeatability: ± 1% of full scale

Cross Sensitivity: Not affected by moisture, food odors, floor cleaners, temperature changes, etc.

Operating Humidity: 0–100% RH (condensing)

Operating Temperatures: –20° F to +140° F

Storage Temperature: –20° F to +140° F

Gas Sampling: Diffusion method with no moving parts

Sampling Frequency: Real time continuous monitoring of all points

Response Time: T⁹⁰ in 10 seconds with full-scale target calibration gas @ .75 liters/min. flow rate

Weight: 4.4 lbs.

Dimensions: 9.59" high x 7.71" wide x 4.52" deep

2 Installation

A Locating the Sensor

Because each sensor can only “report” what it is seeing at the moment, **it is very important that the sensor be located where leaks are most likely to occur.** CFC/ HCFC/HFC vapor is heavier than ambient air, so in a room with no air movement it will tend to settle. For quickest detection, mount the sensor about one to two feet from the floor, close to the potential leak source.

If the primary application is the fastest possible leak detection, mount the sensor near the potential leak sources. In doing this, be aware that the indicated concentration may not be representative of personnel exposure and easy access for the required calibration and maintenance could be compromised.

General Mounting Considerations:

- Must be easily accessible for calibration and maintenance.
- **Always** mount the sensor vertically.
- Mount the sensor close to the potential leak source for fastest possible leak detection.
- If personnel protection is the primary application, mount in the “breathing zone.”
- Protect sensor from water, excessive humidity, and wash-down.
- Take air movement and ventilation patterns into account.

- To prevent electrical interference, keep sensor and wire runs away from mercury vapor lights, variable speed drives, and radio repeaters.
- Protect sensor from physical damage (fork lifts, etc.).
- Do not mount the sensor over a door in a refrigerated area.
- For highly critical locations more than one sensor should be installed in each room.

Very Important:

- Sensor **must** be mounted vertically
- **Never** mount sensor flat on a ceiling
- Enter enclosure **only** through existing hole in bottom of enclosure
- **Always** make a drip loop in the conduit
- **Never** mount sensor on a vibrating surface.

Mount sensor enclosures through the flange holes as shown in Figure 1, and **always** mount vertically.

Penthouses: Multi-Coil (defrost one coil at a time) – In this case the best location is usually in the center of the penthouse four or five feet above the grate.

Single Coil (or when all coils defrost at the same time) – In this case high moisture conditions can occur and the sensor should be mounted one foot above the grate.

Engine Rooms: The AirScan™ iR sensor should be mounted in a cool part of the room, if possible. Keep the sensor away from hot air exhausting from electric motors or other machinery.

Figure 1: Mounting Dimensions for the AirScan™iR Sensor

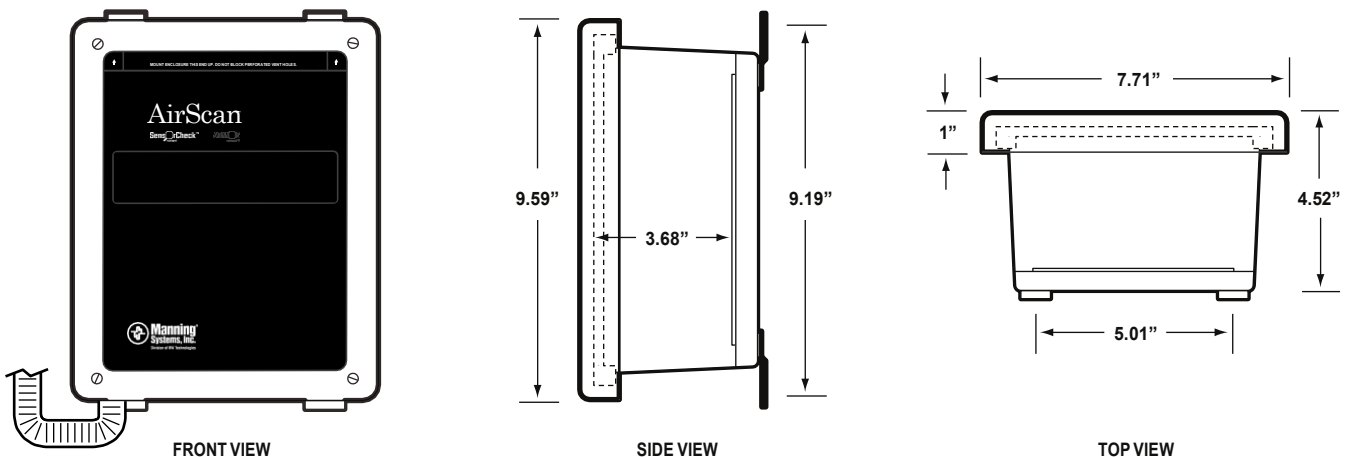

2 Installation continued

Ceiling Hung Evaporators: When mounting AirScan™iR sensors near evaporators, mount the sensor no higher than two feet below the top of the evaporator coil.

Do not mount in high air flow (1,200 feet/minute maximum). **Never** mount the sensor on evaporators as vibration can damage the sensor.

Other Locations: When mounting AirScan™iR sensors in locations such as rooftop air units, ductwork, attic spaces, makeup air intakes, etc., contact Manning Systems for application assistance and recommendations.

B Wiring

Electrical wiring must comply with all applicable codes. Plant equipment that may be involved and operating conditions should be discussed with local operating personnel to determine if any special needs should be considered.

Nearly all start-up problems are due to improper wiring or monitor configuration. Please follow these guidelines carefully.

Always use three conductor, insulated, stranded, shielded copper cable. Use **only** three conductor cable, **not** two cables of two conductor wire (see Figure 2).

If the AirScan™iR is to be used with the AirAlert™96d, please call Manning Systems for specific wiring instructions.

Do not pull sensor wiring with AC power cables. This will cause electrical interference. Be sure there are no breaks or splices in sensor wiring runs. If cable runs cannot be made without a splice, all connections must be soldered. Soldering should be done using a rosin flux to tie the connecting ends of sensor wires to ensure a positive and long-lasting contact.

Ground the shield at the main control panel. Connect the shield wire in the sensor terminal block labeled *shield*. Tape all exposed shield wire at the sensor to insulate it from the enclosure.

All penetrations into a refrigerated room should be sealed to prevent condensate from forming in the conduit and dripping into the sensor enclosure.

Make drip loops for cables going into sensor housings (see Figure 1). Follow the special mounting instructions on the enclosure (...*This End Up*).

Electrical Power: 24 VDC regulated, 1.0 amp.

Output: Circuit board mounted sensor provides a linear 4/20 mA output. Monitoring equipment may have a maximum input impedance of 500 ohms.

Contact Manning Systems for specific wiring instructions when using AirScan™iR sensors with an AirAlert™96d readout unit.

Cable Recommendation: Use #18/3 (Belden #8770) for cable runs up to 200 feet. Use #16/3 (Belden #8618) for cable runs up to 1,000 feet. Use only the existing punched holes for connections to the sensor.

Monitoring: The AirScan™iR Refrigerant Sensor may be monitored by any Manning Systems Readout/Alarm unit or other appropriately configured system. Monitoring equipment must be configured to indicate a fault if the signal is below 1.5 mA. All signals above 20 mA must be considered a high gas concentration. A failed sensor will output a 0.5 mA signal.

Figure 2: Wiring Diagram for the AirScan™iR Sensor

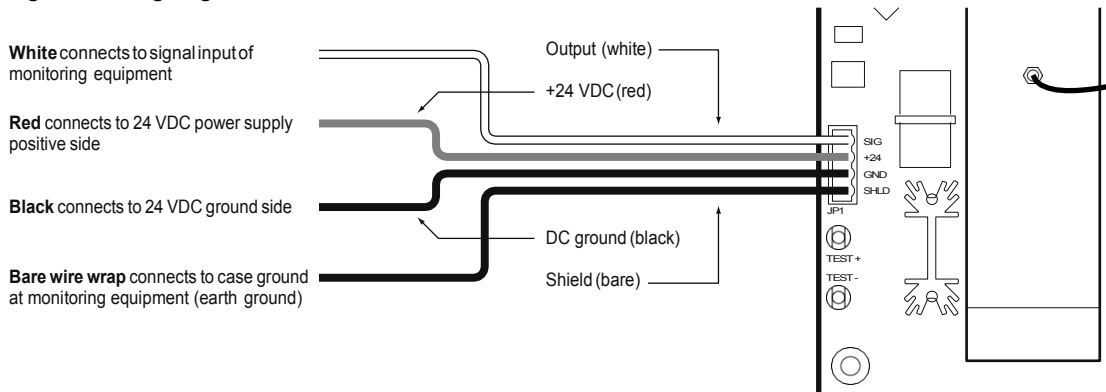

3 Operation

The AirScan™iR has several modes of operation, including two normal run modes, two 4/20 mA loop check modes and five calibration modes. These will be explained in Operation, Section C, Modes of Operation. Modes are entered by properly activating pushbuttons located on the circuit board, shown in Figure 4.

Sensor operation status is indicated by the blink pattern of seven LEDs located in a vertical row on the right side of the sensor circuit board (see Figure 4). LED status is differentiated by color and duration/pattern of blink(s). LED Indicators and Blink Sequences are shown in Figure 6, followed by an explanation of blink patterns.

A Start-Up Procedure

Before applying power, make a final check of all wiring for continuity, shorts, grounds, etc. It is usually best to disconnect external alarms and other equipment from the sensor until the initial start-up procedures are completed.

Check the power supply voltage to the sensor with a digital volt meter set to VDC. Place the black lead on sensor terminal GND and the red lead on +24 (see Figure 4, Note 1). Voltage should be between 21 and 28 VDC. If voltage is outside this range, check power supply and wiring.

After power-up, ensure the LEDs below are operational as follows (see Figure 3):

- Green “Power” LED continuous ON
- Both Fault LED’s are OFF
- Green “source” LED is blinking once every 2 seconds

NOTE: For cold/humid adverse environmental conditions the “ATMOS” LED may be turning on and off periodically. In addition, the “system” LED may be blinking or continuous ON, also described in later sections.

IMPORTANT: The AirScan™iR sensor is factory calibrated and should require minimal adjustments after installation.

CARB Compliance: To ensure continued compliance with CARB performance guidelines, calibrate the unit in the environment in which it will be used. Frequency of calibration can improve accuracy; Honeywell Analytics recommends calibration every 6 months. Environmental factors such as temperature, humidity, and pressure can affect accuracy. Consider these factors when establishing a maintenance program .

Allow the sensor to operate for 12 hours with the enclosure sealed prior to testing the sensors. This will give the sensor time to reach thermal equilibrium to the external and internal temperatures while in operation. Because sensors are normally located at a distance from the main unit, the test time required and accuracy of the response checks will be improved if two people perform the start-up procedures and use radio contact.

Start-Up Test:

- 1) One person exposes each sensor to a small amount of the gas that is being monitored.
- 2) The second person stays at the control unit to determine that each sensor, when exposed to the gas fumes, is connected to the proper input and responds, causing appropriate alarm functions.

Figure 3: Required LED Status at Start-up

LED	WITH OUTPUT FILTERING	WITHOUT OUTPUT FILTERING
POWER G	—————	—————
SYSTEM Y	—————	— — — —
CALIBRATE Y	OFF	OFF
FAULT R	OFF	OFF
mA FAULT R	OFF	OFF
SOURCE G	— — — —	— — — —
ATMOS G	ON PERIODICALLY	ON PERIODICALLY

3 Operation continued

B Pushbutton Operation, LED Indicators, Adjustment Pots and Test Points

The AirScan™iR has two internal pushbuttons, and two adjustment pots that are utilized for navigation of test functions, calibrations, and operating modes. In addition, a pair of test points is also provided that assist in the connection to standard meter leads for use in the upcoming calibration and diagnostic procedures (see Figure 4).

Figure 4: Board Component Layout

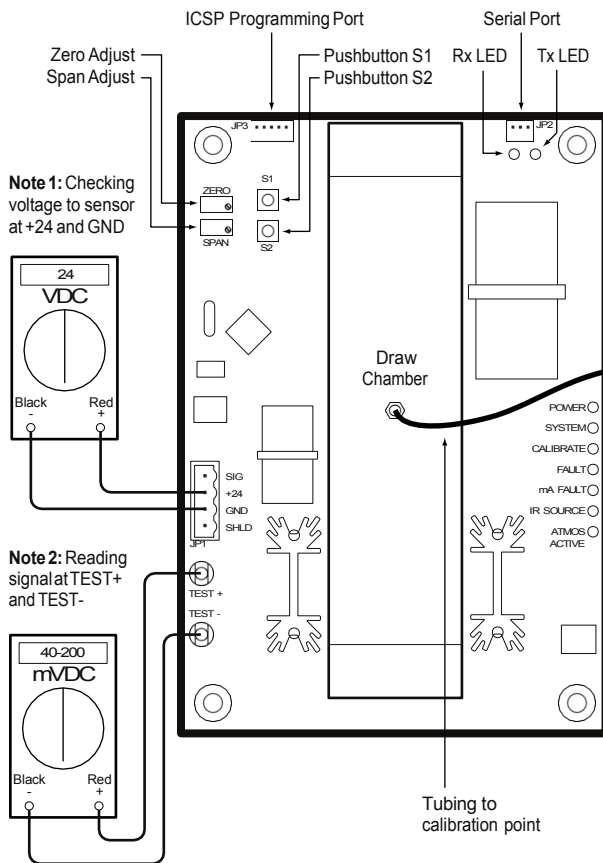

- “Zero” adjustment pot – adjusts output calibration of the 4 mA nominal resting point
- “Span” adjustment pot – adjusts the 20 mA concentration level or unit span/sensitivity.
- Pushbutton S1 – used to initiate the auto-zero function, program the 4 mA output calibration, and initiate the 4/20 mA loop test.
- Pushbutton S2 – used to program the span setting.
- Test(+) and Test(-) for connection to a DC Volt meter (see Figure 4, Note 2).

IMPORTANT: The pushbutton(s) must be pressed the correct number of times and at the correct rate.

- When a multi-press sequence must be performed, the button must be pressed rapidly and evenly, lifting one’s finger completely from the actuator for each consecutive press.
- For press and hold activations, one’s finger must always be applying a down pressure without disruption for the specified time in order to activate the desired mode.
- See complete details of each operation in other parts of the manual.

The AirScan™iR also has a group of LED’s (see Figure 5) that blink in specific sequences (see Figure 6 on next page) to indicate sensor operation and programming modes. A summary of sensor operation and programming modes with corresponding LED blink sequences is shown in Figure 7 on page 10.

Figure 5: LED Layout

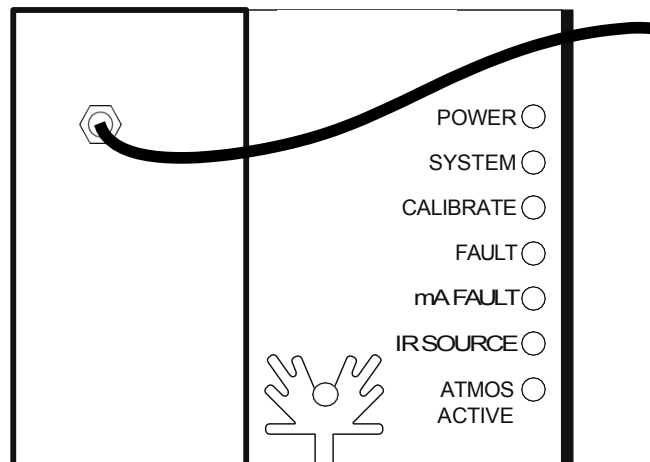

3 Operation continued

LED Indicators and Blink Sequence

Figure 6: LED Blink Sequence

SEQUENCE	1 sec.	2 sec.	3 sec.
SOURCE BLINK	[Solid bar]		
SLOW BLINK	[Dashed bar]	[Dashed bar]	[Dashed bar]
MEDIUM DOUBLE BLINK	[Solid bar]		
FAST BLINK	[Dashed bar]	[Dashed bar]	[Dashed bar]
CONTINUOUS ON	[Solid bar]		

Green Power LED

- Continuous ON when power is applied

Yellow System LED

- Continuous ON during normal filtered output run mode – “dead band” from 4 to 4.6 mA
- Slow blink during normal non-filtered output run mode
- Fast blink indicating unit lost calibration data
- OFF during 4/20 mA loop check

Yellow Calibrate LED

- Continuous momentary ON for auto-zero mode activation
- Slow blink for 4 mA output calibration mode
- Medium double blink indicates 4/20 mA loop check .5 mA (low)
- Fast blink for “span” calibration mode and 4/20 mA loop check 22 mA (high)

Red Fault LED (all scenarios produce a .5 mA output)

- Continuous ON indicates a failed source, low signal, or circuit failure
- Slow blink indicates the power supply DC 24V input voltage is too low.
- Medium double blink indicates sensor is outside the operating temperature range.
- Fast blink indicates the signal drifted below 4 mA and needs to be re-calibrated, only in non-filtered output run mode (no dead-band).

Red mA Fault LED attempts to output .5 mA fault signal

- Fast blink indicates 4/20 mA loop failure or load resistance too high

Green Source LED

- One blink every 2 seconds indicates when source is energized and also that the source is not short circuited.

Green ATMOS LED

- Continuous ON indicates ATMOS circuitry is active or adjusting the enclosure’s internal environmental conditions for the sensor to function reliably.

NOTES:

- If the Source LED isn’t blinking, **do not** proceed until the condition is corrected.
- If a Fault LED is lighted, immediately refer to Fault Indicator Error Sequences (page 11) to determine potential problem. Do not attempt calibration if a Fault is indicated.
- All status LED’s are subordinate to Fault indicators.
- If an LED is indicated as OFF, it must actually be OFF for proper sensor operation.
- If an LED status is N/A (not applicable), that LED indication may vary depending on other operational factors.

3 Operation continued

Figure 7: LED Indicator Summary

↓ = Initiated by button press (G) = GreenLED (Y) = YellowLED (R) = RedLED

See LED indicators and blink sequence descriptions on page 9.

Normal Run Mode

LED	WITH OUTPUT FILTERING ¹	WITHOUT OUTPUT FILTERING ²
POWER (G)	—————	—————
SYSTEM (Y)	—————	- - - - -
CALIBRATE (Y)	OFF	OFF
FAULT (R)	OFF	OFF
mA FAULT (R)	OFF	OFF
SOURCE (G)	- - - - -	- - - - -
ATMOS (G)	ON PERIODICALLY ³	ON PERIODICALLY ³

NOTE 1: Dead-band from 4 mA to 4.6 mA

NOTE 2: No dead-band from 0 to 26 mA

NOTE 3: Environmental compensation energized for cold temperatures

4/20 mA Loop Test Mode

LED	4/20 mA LOOPTEST (22 mA HIGH) ¹	4/20mA LOOPTEST (.5mA LOW) ¹
POWER (G)	—————	—————
SYSTEM (Y)	OFF	OFF
CALIBRATE (Y)	- - - - -	- - - - -
FAULT (R)	N/A	N/A
mA FAULT (R)	N/A	N/A
SOURCE (G)	N/A	N/A
ATMOS (G)	N/A	N/A

NOTE 1: Error on output will result in fast blink on red mA FAULT LED.

Calibration Mode

LED	ZERO FUNCTION INITIATED ¹	DURING SPAN CALIBRATION	DURING 4 mA OUTPUT CALIBRATION	FACTORY CALIBRATION LOST ²
POWER (G)	—————	—————	—————	—————
SYSTEM (Y)	N/A	- - - - -	—————	- - - - -
CALIBRATE (Y)	—————	- - - - -	- - - - -	N/A
FAULT (R)	OFF	OFF	N/A	N/A
mA FAULT (R)	OFF	OFF	OFF	N/A
SOURCE (G)	N/A	N/A	N/A	N/A
ATMOS (G)	N/A	N/A	N/A	N/A

NOTE 1: Indicates that "Zero" function is initiated and pushbutton S1 can be released. Yellow Calibrate LED will be off after pushbutton is released.

NOTE 2: Indicates unit lost the factory calibration data. Contact Manning Systems.

3 Operation continued

Figure 7: LED Indicator Summary, continued

↓ = Initiated by button press (G) = Green LED (Y) = Yellow LED (R) = Red LED

See LED indicators and blink sequence descriptions on page 9.

Fault Indicator Error Sequences

LED	LOST FACTORY CALIBRATION ¹	FAILED 4/20 mA OUTPUT ²	LOW SIGNAL OR FAILED SOURCE OR CIRCUIT	POWER SUPPLY VOLTAGE TOO LOW	OPERATING TEMPERATURE RANGE EXCEEDED
POWER (G)	—————	—————	—————	—————	—————
SYSTEM (Y)	- - - - -	N/A	N/A	N/A	N/A
CALIBRATE (Y)	N/A	N/A	N/A	N/A	N/A
FAULT (R)	N/A	N/A	—————	- - - - -	- - - - -
mA FAULT (R)	N/A	N/A	N/A	N/A	N/A
SOURCE (G)	N/A	N/A	N/A	N/A	N/A
ATMOS (G)	N/A	N/A	N/A	N/A	N/A

NOTE 1: Indicates Normal Run Mode without output filtering where unit lost factory calibration data. Contact Manning Systems for technical support.

NOTE 2: Indicates failed 4/20 mA output signal. Load resistance is too high.

LED	READING DRIFTED BELOW 4 mA ¹	SHORTED SOURCE
POWER (G)	—————	—————
SYSTEM (Y)	N/A	N/A
CALIBRATE (Y)	N/A	N/A
FAULT (R)	- - - - -	—————
mA FAULT (R)	N/A	N/A
SOURCE (G)	N/A	OFF
ATMOS (G)	N/A	N/A

NOTE 1: Indicates the gas reading drifted below 4 mA and needs to be re-calibrated only in non-filtered output run mode (no dead-band).

3 Operation continued

c Modes of Operation

The AirScan™ iR has various modes of operation and calibration:

- Normal run mode with output filtering
- Normal run mode without output filtering
- 4/20 mA loop check
- 4/20 mA calibration to an external PLC or read-out panel
- Neutral gas resting point or “zero” calibration mode
- Span calibration modes

Normal Run Modes

Normal run mode with output filtering

This mode outputs a signal from 4 to 27 mA with a “dead band” from 4 to 4.6 mA. This “dead band” masks small environmental anomalies that could facilitate output signal fluctuations or transients around the 4 mA resting point when the unit is not sensing target gas.

Start: If the “system” LED is blinking slowly, press and hold both S1 and S2 simultaneously for 1 second or more until the “system” LED is continuous ON, then release both buttons. If the “system” LED is blinking fast, this mode cannot be engaged and the factory needs to be contacted. See the following example.

LED	SEQUENCE
POWER G	
SYSTEM (Y)	—————
CALIBRATE Y	OFF
FAULT (R)	OFF
mA FAULT R	OFF
SOURCE (G)	— — — — —
ATMOS G	N/A

Normal run mode without output filtering

This mode outputs a signal that nominally rests at 4 mA and can range continuously from 0 to 27 mA. Any subtle changes in sensor response will be sent to the mA loop output. This mode is entered automatically when the calibration modes are activated. Some users may wish to see the subtle anomalies in the signal near the nominal 4 mA rest area.

Start: If the “system” LED is continuous ON, press and hold both S1 and S2 simultaneously for 1 second or more until the “system” LED is blinking slowly then release both buttons to enter this mode. If the “system” LED is blinking fast this mode is always engaged and can only be exited by fully calibrating the unit. See the following example.

LED	SEQUENCE
POWER G	
SYSTEM (Y)	— — — — —
CALIBRATE Y	OFF
FAULT (R)	OFF
mA FAULT R	OFF
SOURCE (G)	— — — — —
ATMOS G	N/A

3 Operation continued

4/20 mA Loop Test {22 mA full-scale and .5 mA fault check}

Start: Press S1 5 times within a two to three second period of time. The yellow “system” LED will turn off and the yellow “calibrate” LED will blink fast. See the following example. Output should be 21 to 22.5mA.

22 mA Full Scale Output Test

LED	SEQUENCE
POWER G	
SYSTEM (Y)	OFF
CALIBRATE Y	
FAULT (R)	N/A
mA FAULT R	N/A
SOURCE (G)	N/A
ATMOS G	N/A

To proceed to the next step in the mA test, press and hold S1 for 1 second or more until the yellow “calibrate” LED is a medium double blink. See the following example. The output should be between .4 and .6mA.

.5 mA Fault Output Test

LED	SEQUENCE
POWER G	—————
SYSTEM (Y)	OFF
CALIBRATE Y	
FAULT (R)	N/A
mA FAULT R	N/A
SOURCE (G)	N/A
ATMOS G	N/A

Exit: Press and hold S1 for 1 second or more until the yellow “system” LED resumes the state before the mA test was initiated and the yellow “calibrate” LED turns off.

3 Operation continued

Calibration/Programming Modes:

Refer to *Calibration, Section D* before proceeding.

Auto “ZERO” Program Function

Start: Press and hold S1 for 1 second or until the yellow “calibrate” LED turns continuous ON. Release S1 and the yellow “calibrate” LED will turn off. This indicates the unit “zero” is now programmed to a neutral or 4 mA resting state for **0 ppm of target gas**.

LED	SEQUENCE
POWER G	—————
SYSTEM (Y)	N/A
CALIBRATE Y	—————
FAULT (R)	OFF
mA FAULT R	OFF
SOURCE (G)	N/A
ATMOS G	N/A

“Span” Calibration/Programming Mode

Start: Press and hold S2 for 1 second or until the yellow “system” LED blinks slowly and the yellow “calibrate” LED blinks fast. Once in this mode the “span” pot can be adjusted to determine the 20 mA full-scale concentration.

LED	SEQUENCE
POWER G	—————
SYSTEM (Y)	— — — — —
CALIBRATE Y	— — — — —
FAULT (R)	OFF
mA FAULT R	OFF
SOURCE (G)	N/A
ATMOS G	N/A

Exit: To program the “span” setting and exit this mode, press and hold S2 for 1 second or until the yellow “system” LED resumes the state before the calibration mode was initiated and the yellow “calibrate” LED turns off.

4 mA Output Calibration/Programming Mode

Start: Press and hold S1 for 7 seconds or until the yellow “system” LED turns continuous ON and the yellow “calibrate” LED blinks slowly. See the following example.

Once in this mode the “zero” pot can be adjusted to calibrate the 4 mA output to a PLC, SCADA system, panel, etc.

LED	SEQUENCE
POWER G	—————
SYSTEM (Y)	—————
CALIBRATE Y	— — — — —
FAULT (R)	N/A
mA FAULT R	OFF
SOURCE (G)	N/A
ATMOS G	N/A

Exit: To program the 4 mA calibration point and exit this mode, press and hold S1 for 1 second or until the yellow “system” LED resumes the state before the calibration mode was initiated and the yellow “calibrate” LED turns off.

3 Operation continued

D Calibration

Before calibrating the unit, ensure the startup procedure was followed and unit was powered on for a minimum of 12 hours (with the enclosure door closed) in the operating environment.

IMPORTANT NOTE: For environments where the ambient temperature is less than 10° F, during the calibration procedure, the door must be closed as far as possible. This will ensure the sensor temperature will not drop below the minimum operating temperature which could adversely affect the programmed calibration parameters.

There are only two adjustment pots and two pushbuttons on the main board that are used for programming the calibration parameters. See *Section B, Pushbutton Operation, LED Indicators, Adjustment Pots and Test Points*. Use Section B to familiarize yourself with the pushbuttons S1, S2, adjustment pots “zero”, “span”, Test(+), Test(-) and their locations on the main board (see Figure 8).

Figure 8: Board Component Layout

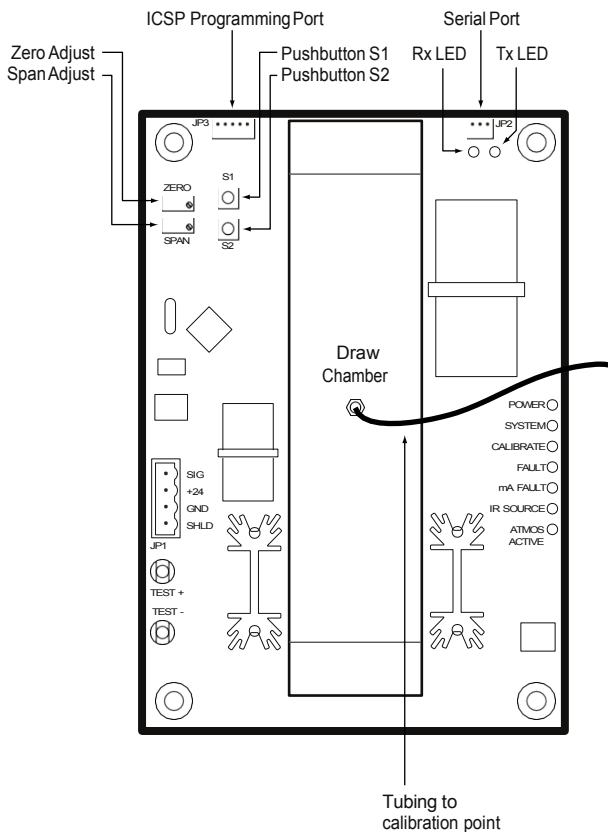

In addition, the LED indicators and blink pattern meanings are also summarized in this section. The calibration procedure will require use and knowledge of the following tools within the sensor:

- “Zero” adjustment pot – adjusts output calibration of the 4 mA nominal resting point
- “Span” adjustment pot – adjusts the 20 mA concentration level or unit span/sensitivity
- Pushbutton S1 – used to initiate the auto-zero function and program the 4 mA output calibration
- Pushbutton S2 – used to program the span setting

In addition, there are four LED’s used in the calibration procedure. Yellow “system” and “calibrate”, and red “fault” and “mA fault” LED’s located on the main board are utilized as status indicators during the calibration procedure and as diagnostic and trouble indicators.

Non-calibrated Sensor or Loss of Factory Calibration

IMPORTANT: Upon power up, if the yellow “system” LED is showing a fast blink pattern, the unit hasn’t been calibrated yet or has lost the factory calibration and requires a **full** calibration before it can reliably read the target gas. See the following example. Should this occur, please contact Manning Systems for assistance!

LED	SEQUENCE
POWER G	
SYSTEM Y	— — — — —
CALIBRATE Y	N/A
FAULT R	N/A
mA FAULT R	N/A
SOURCE G	N/A
ATMOS G	N/A

3 Operation continued

Before continuing with the calibration procedure, determine which of the two Normal output modes is best for the control scheme. Filtered output holds a stable 4 mA signal within a dead-band range while the non-filtered output allows the signal to be seen without any output limitations.

After this output mode choice is made, continue through Steps 1–3 of the Calibration Procedure. As a first step, the 4 mA output is matched to the signal input device being used as a control panel. After this is accomplished, Step 2 (Zero Calibration) and Step 3 (Span Calibration) can be completed in that order.

Filtered Output Mode

Each unit is equipped with a filtered output or “dead band” output mode which locks the output at 4 mA for signal readings of 4 to 4.6 mA. This masks surrounding abrupt adverse environmental transients that would cause a small short-term anomaly on the 4 mA resting point for a near 0 ppm reading of the target gas. In this mode, the yellow “system” LED will be ON. See the following example.

LED	SEQUENCE
POWER G	
SYSTEM (Y)	—————
CALIBRATE Y	OFF
FAULT (R)	OFF
mA FAULT R	OFF
SOURCE (G)	— — — — —
ATMOS G	N/A

Non-Filtered Output Mode (no signal deadband)

Start: Press and hold both the “zero” (S1) and “span” (S2) buttons simultaneously for one second or until the “system” LED begins to blink slowly. See example below.

This mode will allow any anomalies to be transmitted from 0 to 27 mA on the output. This mode is also used in the upcoming Simple Zero Test procedure.

LED	SEQUENCE
POWER G	—————
SYSTEM (Y)	— — — — —
CALIBRATE Y	OFF
FAULT (R)	OFF
mA FAULT R	OFF
SOURCE (G)	— — — — —
ATMOS G	N/A

Exit: To revert back to “dead band” mode, repeat the same button press procedure above. This button press sequence will toggle between modes (filtered to non-filtered).

3 Operation continued

STEP 1

4-20 mA Output Calibration

This procedure calibrates the 4/20 mA output to match a PLC input converter or various devices that interpret the 4/20 mA signal output to ensure the 4 mA output rests at a true 4 mA even with minor mismatches in load resistance, long feed wiring, or adverse environmental conditions.

Start: Set meter to mV DC and place meter leads on Test(+) and Test(-) respectively (see Figure 9).

- Press and hold the “zero” button (S1) for 5 seconds or until the “calibrate” LED is blinking slowly and the “system” LED is continuous ON. Make sure the “mA Fault” LED is OFF.
- Adjust the zero potentiometer until the output reads 3.99 to 4.01 mA (39.9 to 40.1 mV). This sets the 4 mA resting point. Make small adjustments and wait for the output to change because adjustment response is delayed between source pulses.

4 mA output programming calibration mode

LED	SEQUENCE
POWER G	—————
SYSTEM Y	—————
CALIBRATE Y	—————
FAULT R	N/A
mA FAULT R	OFF
SOURCE G	N/A
ATMOS G	N/A

Exit: Press and hold the “zero” button (S1) for one second or more until the “calibrate” LED turns off.

The “system” LED will resume the previous state, either “filtered” or “non-filtered” output mode. This indicates the parameters are now programmed into memory.

STEP 2

Zero Calibration

This procedure sets the internal reference that is indicative of 0 ppm of target gas. **It MUST be performed before proceeding or every other setting will be offset and inaccurate.** The “zero” can be initiated at any time as long as a neutral gas is flowing through the calibration port or the surrounding air is known to be FREE of any target gas down to 1 ppm.

Start: Apply pure nitrogen (N₂) into the calibration port at a rate of .6 liter/min. for at least 3 minutes (OR until output signal is within ± .02 mA of signal deviation/change).

- Press and hold the “zero” button (S1) for approximately 1 second or until the yellow “calibrate” LED is continuous ON.
- When yellow calibration LED is continuous ON, release the “zero” button. The “calibrate” LED will turn off and the unit will be zeroed. See example below.

“Zero” programming calibration mode

LED	SEQUENCE
POWER G	—————
SYSTEM Y	N/A
CALIBRATE Y	—————
FAULT R	OFF
mA FAULT R	OFF
SOURCE G	N/A
ATMOS G	N/A

Exit: System will automatically resume previous mode, either “normal” or “no dead band” mode. This indicates the parameters are now programmed into memory.

Place multi-meter leads on Test(+) and Test(-) and ensure the output is steadily resting between 3.9 to 4.1 mA (see Figure 9 on next page). If this isn’t the case, initiate the auto “zero” procedure once again.

3 Operation continued

Figure 9: Board Component Layout

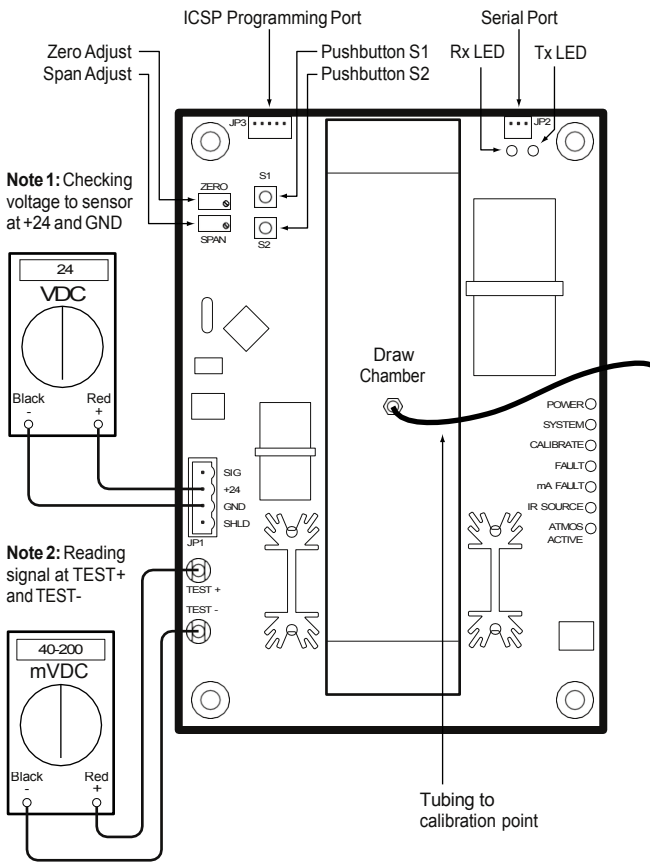

Note 1: Checking voltage to sensor at +24 and GND

Note 2: Reading signal at TEST+ and TEST-

Press and hold the “span” button (S2) for 1 second or more until the yellow “calibrate” LED blinks fast and the yellow “system” LED is blinking slowly. See the following example.

LED	SEQUENCE
POWER G	
SYSTEM Y	— — — —
CALIBRATE Y	
FAULT R	OFF
mA FAULT R	OFF
SOURCE G	N/A
ATMOS G	N/A

Ensure the output rests between 3.9 and 4.1 mA (39.0 to 41.0 mV). If this is not the case, perform the “zero” procedure again.

Once the output is within the required range with nitrogen flowing, apply **full-scale** target gas into the calibration port at a rate of .6 liters/min for 3 minutes immediately following the nitrogen flow.

If the signal is 26 mA or greater, adjust the “span” potentiometer counter-clockwise until the signal is near 20 mA. **Because there is a slight delay in potentiometer movement, make small adjustments and wait for the output to change because adjustment response is delayed between source pulses.**

Wait until the output signal has stabilized to within $\pm .02$ mA of signal deviation/change. Adjust the “span” potentiometer again until the output reads around 20 mA.

Exit: Press and hold the “span” button (S2) for one second or more until the yellow “calibrate” LED turns off. The yellow “system” LED will resume the previous state, either “filtered” or “non-filtered” output mode. This indicates the parameters are now programmed into memory.

STEP 3

Span Calibration

This procedure sets the “span” or concentration level that would depict a 20 mA reading for full-scale target gas on the 4/20 mA output. The lower the target gas concentration is for a span of 20 mA, the more sensitive or responsive the unit would be to lower ppm readings.

NOTE: This procedure should only be performed if the zero and 4/20 mA procedures are successfully completed.

Start: Set meter to mVDC, place meter leads on Test(+) and Test(-) respectively (see Figure 9).

Apply **pure nitrogen** (N_2) into the calibration port at a rate of .6 Liter/min. for at least 3 minutes (OR until output signal has stabilized to within $\pm .02$ mA of signal deviation/change). If N_2 is currently flowing from previous “zero” calibration, disregard the additional flow time.

3 Operation continued

E Diagnostic Procedures

Simple Zero Test

This test will ensure the unit is calibrated for a true “zero” and duly represents an absence of target gas in this condition.

Start: Set meter to mV DC, place meter leads on Test(+) and Test(–) respectively (see Figure 9).

- Apply **pure nitrogen** (N₂) into the calibration port at a rate of .6 Liter/min. for at least 3 minutes. Check the status of the yellow “system” LED. If this LED is continuous ON, place the unit in non-filtered output run mode by pressing both the “zero” (S1) and “span” (S2) buttons simultaneously for 1 second or until the “system” LED begins to blink slowly. See example below.
- Wait until output signal has stabilized to within ±.02 mA of signal deviation/change.
- Output should read between 3.9 and 4.1 mA (39.0 to 41.0 mV).

If this is not the case, proceed to the next step.

- Follow the “zero” procedure above to re-zero the unit
- Follow the “simple zero test” procedure to ensure the unit is resting at the optimum 4 mA point.

Simple “Zero” test – NO “Dead-band” mode 0 to 26 mA

LED	SEQUENCE
POWER G	
SYSTEM (Y)	—————
CALIBRATE Y	OFF
FAULT (R)	OFF
mA FAULT R	OFF
SOURCE (G)	—————
ATMOS G	N/A

Exit: Press and hold both the “zero” (S1) and “span” (S2) buttons simultaneously for 1 second or more until “system” LED is continuous ON. Unit should be ready for long-term operation.

4/20 mA Output Loop Integrity Check

22 mA High Signal Test

STEP 1

Start: Set meter to mV DC, place meter leads on Test(+) and Test(–) respectively (see Figure 9).

- Press the “zero” (S1) button 5 times. The yellow “calibrate” LED will blink fast and the yellow “system” LED will turn off. The output should be 21 to 22.5 mA (210 to 225 mV).

If a problem exists on the output signal line, or the output load is not within the specified range, the “mA fault” LED will blink either before or upon activation of this test. In some cases the 22 mA high signal output will cause incorrect output load resistance values to surface because of the demand on high resistances to produce high currents.

Low power supply voltages can also be something to investigate if this error surfaces only when the 22 mA high test is initiated.

During 4/20 mA loop test (22 mA high)

LED	SEQUENCE
POWER G	
SYSTEM (Y)	OFF
CALIBRATE Y	
FAULT (R)	N/A
mA FAULT R	N/A
SOURCE (G)	N/A
ATMOS G	N/A

3 Operation continued

During 4/20 mA loop test (22 mA high) w/ Error on output

LED	SEQUENCE
POWER G	—————
SYSTEM (Y)	OFF
CALIBRATE Y	
FAULT (R)	N/A
mA FAULT R	
SOURCE (G)	N/A
ATMOS G	N/A

During 4/20 mA loop test (.5 mA low)

LED	SEQUENCE
POWER G	—————
SYSTEM (Y)	OFF
CALIBRATE Y	
FAULT (R)	N/A
mA FAULT R	N/A
SOURCE (G)	N/A
ATMOS G	N/A

.5 mA Low Signal Output Test for Fault Conditions

NOTE: The unit must be in the 4/20 mA loop (22 mA high) test to proceed with this test.

STEP 2

Start: Press and hold the “zero” (S1) button for at least one second or until the yellow “calibrate” LED shows medium double blink. The yellow “system” LED will remain off and the output should change to .4 to .6 mA (4 to 6 mV).

If a problem exists on the output signal line, or the output load is not within the specified range, the “mA fault” LED will blink either before or upon activation of this test.

If an error surfaces during this test only, the possibility of cross-talk can exist on the signal line. This is caused by resistive shorts to power or other voltage sources that can raise the .5 mA target current on the line. Moisture in the connector can cause stray voltage to migrate from the 24V DC pin over to the 4/20 mA signal line. Check connectors or refer to the troubleshooting section or error code analysis section for assistance.

During 4/20 mA loop test (.5 mA low) with Error

LED	SEQUENCE
POWER G	—————
SYSTEM (Y)	OFF
CALIBRATE Y	—————
FAULT (R)	N/A
mA FAULT R	
SOURCE (G)	N/A
ATMOS G	N/A

STEP 3

Exit: Press and hold the “zero” (S1) button for at least one second or until the yellow “calibrate LED turns off. The yellow “system” LED will resume the previous state, either “filtered” or “non-filtered” output mode.

NOTE: In addition to test procedures initiated manually, every 2 seconds SensorCheck™ technology monitors several performance parameters of the AirScan™ iR. A notification of .5 mA on the output signal is transmitted if any of these parameters is not met.

3 Operation continued

F Troubleshooting

Electrical Interference

This sensor has been designed to be highly resistant to EMI/RFI using multiple stages of filtering and protection. However, in extreme environments, some noise pickup can occur directly through the sensor. Insure that the bare shield wire of the instrument cable is properly connected at the readout unit. See Figure 10, Note 2 for AirScan™iR meter test points.

Figure 10: Troubleshooting the AirScan™iR

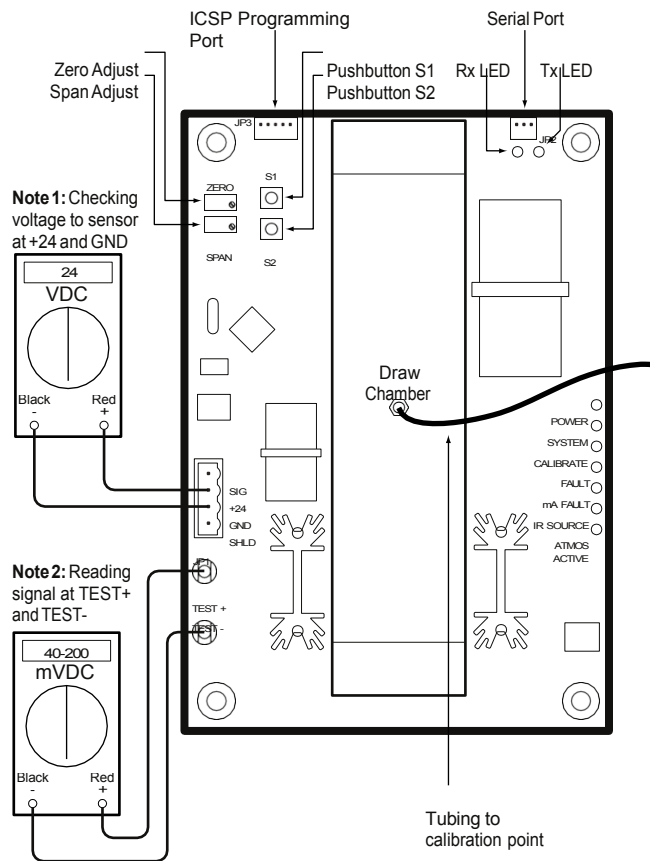

Sensor On-board Diagnostic System

It is possible to have the mA output fail during normal run mode. In some instances a mA output circuit that is incorrectly setup can supply 4 mA to the load reasonably well; however, an incorrect circuit arrangement could not be capable of driving 20 mA to the load when required. Therefore, the system will place a fault condition out on the mA loop output and flash the “mA fault” LED indicating the output wiring is not correct or load resistance is too high.

To properly ensure the load is correct, during the 20 mA or (high) 4/20 mA integrity test, the output circuit

dynamic range is tested to its fullest extent. If the mA fault LED blinks during this test, the load resistance is too high or power supply voltage is too low.

In the case of a mA Failure during Run mode, the “mA fault” LED will blink Fast.

In the case of a mA failure during the mA output test, the “mA fault” LED will also blink Fast. See figure at the top of the next page.

3 Operation continued

Error on 4/20 mA output or during 4/20 mA test 20 mA high

LED	SEQUENCE
POWER G	—————
SYSTEM (Y)	N/A
CALIBRATE Y	
FAULT (R)	N/A
mA FAULT R	—————
SOURCE (G)	N/A
ATMOS G	N/A

To resolve this issue, Place a resistor having at least 100 to 250 ohms across the signal output (SIG) and ground (GND). The “mA fault” LED will stop blinking indicating the load or wiring has a problem.

Sensor Output at 0 mA

Verify +24 VDC at the sensor terminal block (see Figure 10, Note 1 on previous page).

Check signal voltage between Test(+) and Test(-) (see Figure 10, Note 2). Voltage should be in the range of 40 to 200 mV corresponding to an actual current flow of 4 to 20 mA. If this voltage is 0 mV, the signal has no path to ground. Check monitoring equipment connections and configuration. Input impedance must be 500 ohms or less.

Sensor Output at .5 mA

Please see Section D on page 15 for possible fault conditions related to .5 mA output.

Gas Concentration Indicated With No Refrigerant Present

The AirScan™-iR is designed to be quite specific to CFC/HCFC/HFC's that are colorless, odorless gases which can't be sensed by humans at low levels. Always double-check with another instrument before assuming refrigerants are not present.

Performing a zero and a span calibration using certified calibration gas will confirm or correct the sensor's reading.

IR Source Failure

If the IR source signal strength drops to the point that the unit can no longer function satisfactorily, the “fault” LED will remain continuous ON and the 4/20 mA output will be set to 0.5 mA. See example below. This condition can also occur in environments where there is a significant amount of particulate contamination.

Usually it takes an appreciable amount of time for the particles to pose signal degradation, however, under long-term exposure the filter surface could be dirty causing low thermal readings, hence marginal operation for signal analysis.

LED	SEQUENCE
POWER G	—————
SYSTEM (Y)	N/A
CALIBRATE Y	N/A
FAULT (R)	—————
mA FAULT R	N/A
SOURCE (G)	N/A
ATMOS G	N/A

NOTE: 4/20 mA will be set to 0.5 mA.

4 Maintenance

Expose each sensor to test gases monthly to verify that the sensor has a normal response. This will also check the alarm lights and relay action of the monitoring equipment.

It is essential that signal voltages be taken and logged on a consistent basis at least monthly. Periodically, sensors should be exposed to refrigerant sample and the results logged.

For proper operation it is essential that the test and calibration schedule be adhered to. Manning Systems recommends the following maintenance schedule:

- Calibration should be performed with certified calibration gas every six months. Calibration kits are available from Manning Systems.
- All tests and calibrations must be logged. It is highly recommended that certified calibration gas be used every six months.

5 Replacement Parts

For replacement parts, contact Manning Systems. Be sure to give serial number of unit and model number.

6 Limited Warranty

1. Limited Warranty

Honeywell Analytics, Inc. warrants to the original purchaser and/or ultimate customer (“Purchaser”) of this Manning product (“Product”) that if any part thereof proves to be defective in material or workmanship within eighteen (18) months of the date of shipment by Honeywell Analytics or twelve (12) months from the date of first use by the purchaser, whichever comes first, such defective part will be repaired or replaced, free of charge, at the discretion of Honeywell Analytics if shipped prepaid to Honeywell Analytics at 405 Barclay Boulevard, Lincolnshire, Illinois 60069 in a package equal to or in the original container. The Product will be returned freight prepaid and repaired or replaced if it is determined by Honeywell Analytics that the part failed due to defective materials or workmanship. The repair or replacement of any such defective part shall be Honeywell Analytics’ sole and exclusive responsibility and liability under this limited warranty.

2. Exclusions

- A. If gas sensors are part of the Product, the gas sensor is covered by a twelve (12) month limited warranty of the manufacturer.
- B. If gas sensors are covered by this limited warranty, the gas sensor is subject to inspection by Honeywell Analytics for extended exposure to excessive gas concentrations if a claim by the Purchaser is made under this limited warranty. Should such inspection indicate that the gas sensor has been expended rather than failed prematurely, this limited warranty shall not apply to the Product.
- C. This limited warranty does not cover consumable items, such as batteries, or items subject to wear or periodic replacement, including lamps, fuses, valves, vanes, sensor elements, cartridges, or filter elements.

3. Warranty Limitation and Exclusion

Honeywell Analytics will have no further obligation under this limited warranty. All warranty obligations of Honeywell Analytics are extinguishable if the Product has been subject to abuse, misuse, negligence, or accident or if the Purchaser fails to perform any of the duties set forth in this limited warranty or if the Product has not been operated in accordance with instructions, or if the Product serial number has been removed or altered.

4. Disclaimer of Unstated Warranties

THE WARRANTY PRINTED ABOVE IS THE ONLY WARRANTY APPLICABLE TO THIS PURCHASE. ALL OTHER WARRANTIES, EXPRESS OR IMPLIED, INCLUDING, BUT NOT LIMITED TO, THE IMPLIED WARRANTIES OF MERCHANTABILITY OR FITNESS FOR A PARTICULAR PURPOSE ARE HEREBY DISCLAIMED.

5. Limitation of Liability

IT IS UNDERSTOOD AND AGREED THAT HONEYWELL ANALYTICS’ LIABILITY, WHETHER IN CONTRACT, IN TORT, UNDER ANY WARRANTY, IN NEGLIGENCE OR OTHERWISE SHALL NOT EXCEED THE AMOUNT OF THE PURCHASE PRICE PAID BY THE PURCHASER FOR THE PRODUCT AND UNDER NO CIRCUMSTANCES SHALL HONEYWELL ANALYTICS BE LIABLE FOR SPECIAL, INDIRECT, OR CONSEQUENTIAL DAMAGES. THE PRICE STATED FOR THE PRODUCT IS A CONSIDERATION LIMITING HONEYWELL ANALYTICS’ LIABILITY. NO ACTION, REGARDLESS OF FORM, ARISING OUT OF THE TRANSACTIONS UNDER THIS WARRANTY MAY BE BROUGHT BY THE PURCHASER MORE THAN ONE YEAR AFTER THE CAUSE OF ACTIONS HAS OCCURRED.