



**System 57**

**Master Alarm Update Module Kit (05701-A-0309)**

**Alarm Update Panel (05701-A-0339)**

---

## Helping to make a safer world

---

Ensure that you read and understand these instructions **BEFORE** operating the equipment.

Please pay particular attention to the Safety Warnings.



### WARNINGS

The items of equipment covered by this manual are:

1. Not designed or certified for use in hazardous areas.
2. Designed for indoor use only.
3. Not to be exposed to rain or moisture.

### CAUTIONS

1. Use only approved parts and accessories with this control system.
2. To maintain safety standards, regular maintenance, calibration and operation of this control system by qualified personnel is essential.

### IMPORTANT NOTICES

1. Zellweger Analytics Limited can take no responsibility for installation and/or use of its equipment if this is not done in accordance with the appropriate issue and/or amendment of the manual.
2. The user of this manual should ensure that it is appropriate in all details to the exact equipment to be installed and/or operated. In doubt, the user should contact Zellweger Analytics Limited for advice.

Zellweger Analytics Limited reserve the right to change or revise the information supplied in this document without notice and without obligation to notify any person or organisation of such revision or change.

If further details are required which do not appear in this manual, contact Zellweger Analytics Limited or one of their agents.

---

## GLOSSARY

---

A1	-	First Level Gas Alarm. Lower or pre-warning alarm.
A2	-	Second Level Gas Alarm. Intermediate warning alarm.
A3	-	Third Level Gas Alarm. Upper warning alarm.
LED	-	Light Emitting Diode.
* LTEL	-	Long Term Exposure Limit. (8 hours TWA value).
RFI	-	Radio Frequency Interference
RH	-	Relative Humidity.
* STEL	-	Short Term Exposure Limit. (10 minutes TWA value).
* TWA	-	Time Weighted Average.

\* Refer to the appropriate National Standards Authority for details. In the UK this detail is in the Guidance Note EH 40/89 from the Health and Safety Executive on Occupational Exposure Limits 1989.

## HELP US TO HELP YOU

Every effort has been made to ensure the accuracy in the contents of our documents, however, Zellweger Analytics Limited can assume no responsibility for any errors or omissions in our documents or their consequences.

Zellweger Analytics Limited would greatly appreciate being informed of any errors or omissions that may be found in the contents of any of our documents and to this end we include the form opposite for you to photocopy, complete and return to us so that we may take the appropriate action.



---

# CONTENTS

---

Section	Page
GLOSSARY	3
1. INTRODUCTION	7
1.1 Principal Features	7
1.2 Construction	8
2. CONTROLS AND FACILITIES	12
2.1 Introduction	12
2.2 Master Alarm Update Module Facilities	12
2.2.1 Update Outputs	12
2.2.2 Control Inputs	14
2.3 Master Alarm Update Panel	14
2.3.1 Switch Inputs	14
2.3.2 Audible and Visual Outputs	16
3. INSTALLATION INSTRUCTIONS	17
3.1 Introduction	17
3.2 Unpacking	20
3.3 Installing the Master Alarm Update Kit	20
3.4 Installing the Master Alarm Update Panel	22
3.5 System Connections	23
3.5.1 General	23
3.5.2 Cabling	23
3.5.3 Update 1 - Open Collector Transistor Output	26
3.5.4 Update 2 - Relay Output	26
3.5.5 Update Accept Input	27
3.5.6 Master Alarm Reset Input	28

---

## CONTENTS

---

Section	Page
4. CONFIGURATING THE UPDATE FUNCTION	30
4.1 General	30
4.2 Update Output Configuration:	30
4.3 Control Input Configuration	30
5. COMMISSIONING AND MAINTENANCE INSTRUCTIONS	31
5.1 Start Up Procedure	31
5.2 Maintenance	32
5.3 Fault Finding	32
6. OPERATING INSTRUCTIONS	34
7. SPECIFICATION	35
7.1 Environmental	35
7.2 EMC/RFI Conformity	35
7.3 Master Alarm Update Module	35
7.4 Master Alarm Update Panel	36

## FIGURES

1. Master Alarm Update Module	9
2. Front View of Alarm Update Panel.	10
3. Master Alarm Update Overview	11
4. Alarm Update Sequence	15
5. System 57- Engineering Card Mark I	18
5. System 57- Engineering Card Mark II	19
7. Master Alarm Update Panel Connections	22
8. Front Access Connections for DC Input Card and Master Alarm Update Option Module	24
9. Rear Access Connections for DC Input Card and Master Alarm Update Option Module	25
10. Wiring Example - Update 1 Driving a Lamp	26
11. Wiring Example - Update 2 Operating an External a Sounder	27
12. Update Accept Remote Switch Connection	28
13. Master Alarm Reset Remote Switch Connection	29

---

# 1. INTRODUCTION

---

## 1.1 PRINCIPAL FEATURES

The System 57 Master Alarm Update option provides an extra facility for common alarm outputs. This facility provides an indication when a new alarm occurs on any channel within the rack, even if a previous alarm condition already exists. This is useful in systems configured with only a master or group/zone relays where, once an initial alarm has activated the relay outputs, the occurrence of subsequent alarms will not cause further relay outputs.

The principal features of the update facility are:

- Easily fitted to the Engineering Card.
- Simple field connections via the DC Input Card terminal block for wire up to 2.5mm<sup>2</sup> (14 AWG).
- Provides update output based on the Fault, Inhibit, A1, A2, A3, STEL, LTEL and Rate alarms from all cards in the rack.
- Compatible with the 5701 and 5704 Control Cards.
- Single pole relay output.
- Open collector transistor output with thermal protection.
- Alarm Update Accept input.
- Master Alarm Reset input.
- Easily configured using the Engineering Interface Software

The Master Alarm Update facility can be enhanced by adding the optional Master Alarm Update Panel. The rack mounted 1" wide panel provides one audible and one visual alarm output, and two push-button switches. This provides convenient access to the update facilities without the need for external wiring.

---

# 1. INTRODUCTION

---

The principal features of the update panel are:

- Neat 1" wide integrated panel design.
- Large high intensity led lamp for visual indication.
- Sounder for audible indication.
- Push-button for Master Alarm Reset.
- Push-button for Alarm Update Accept.
- Existing relay and transistor outputs, and remote inputs can still be used.

## 1.2 CONSTRUCTION

The System 57 Master Alarm Update facility is available pre-installed in new systems or as a kit for retrofitting into existing systems. The kit consists of a small pcb module and an integrated circuit that are plugged into the expansion sockets provided on the Engineering Card. Connections for the update outputs and remote inputs are made via the six way expansion terminal block that is located on the DC Input Card.

An enhanced version of the Engineering Card software must be installed in order to provide the master alarm update functions. The new software is fully compatible with the original Engineering Card software and is provided in the kit in the form of a plug-in integrated circuit.

The layout of the Master Alarm Update Module is shown in Figure 1.

The Master Alarm Update Panel is a 1" wide 3U high panel with a flying lead that plugs through a slot in the Engineering Card onto the Master Alarm Update Module. The panel occupies a single slot within the rack immediately adjacent to the Engineering Card.

The layout of the Master Alarm Update Panel is shown in Figure 2

# 1. INTRODUCTION

## Update 2 Mode Control

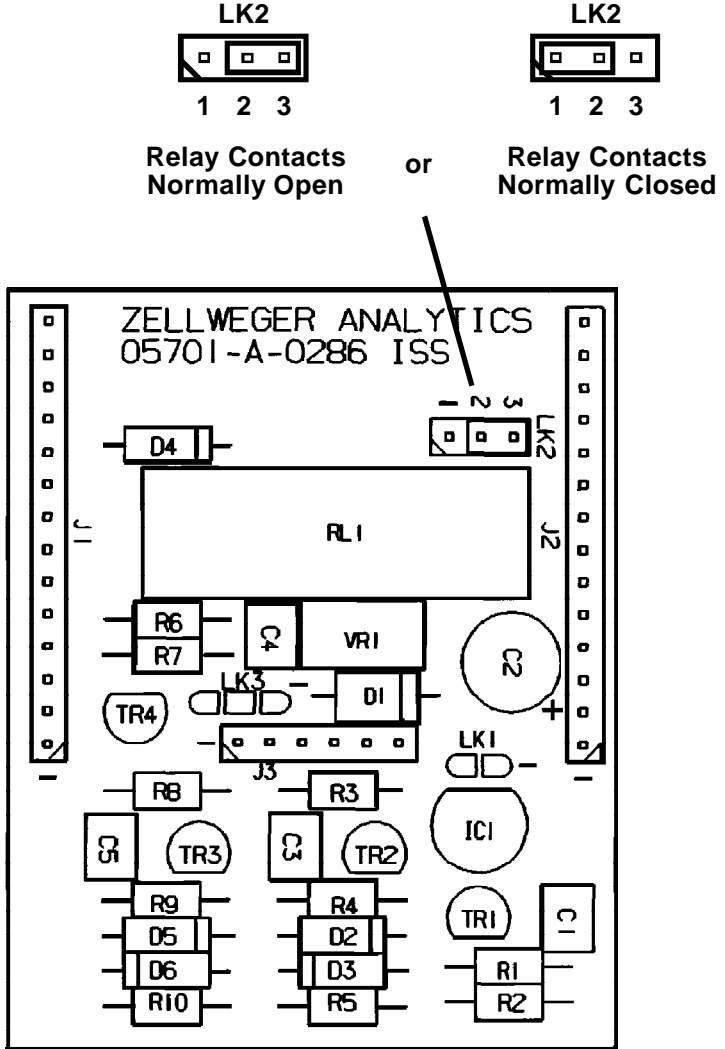

Figure 1 Master Alarm Update Module

---

# 1. INTRODUCTION

---

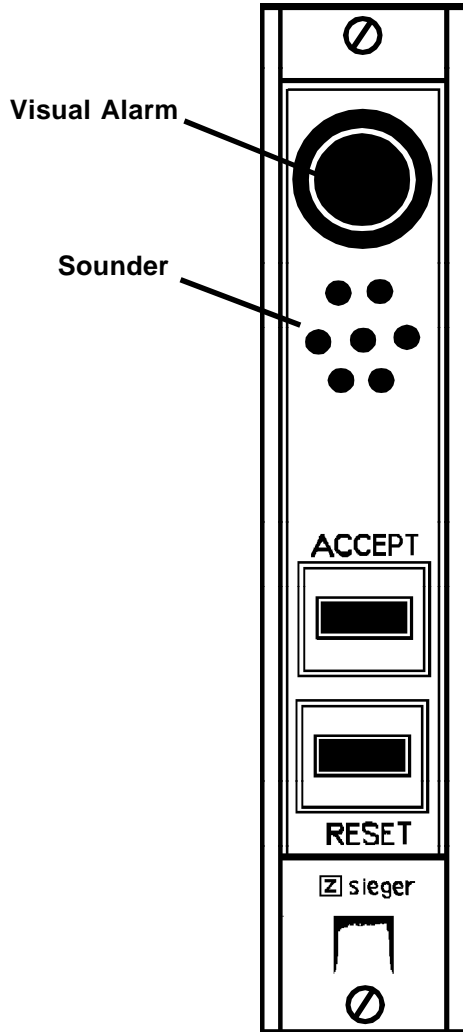

Figure 2 Front View of Alarm Update Panel.

# 1. INTRODUCTION

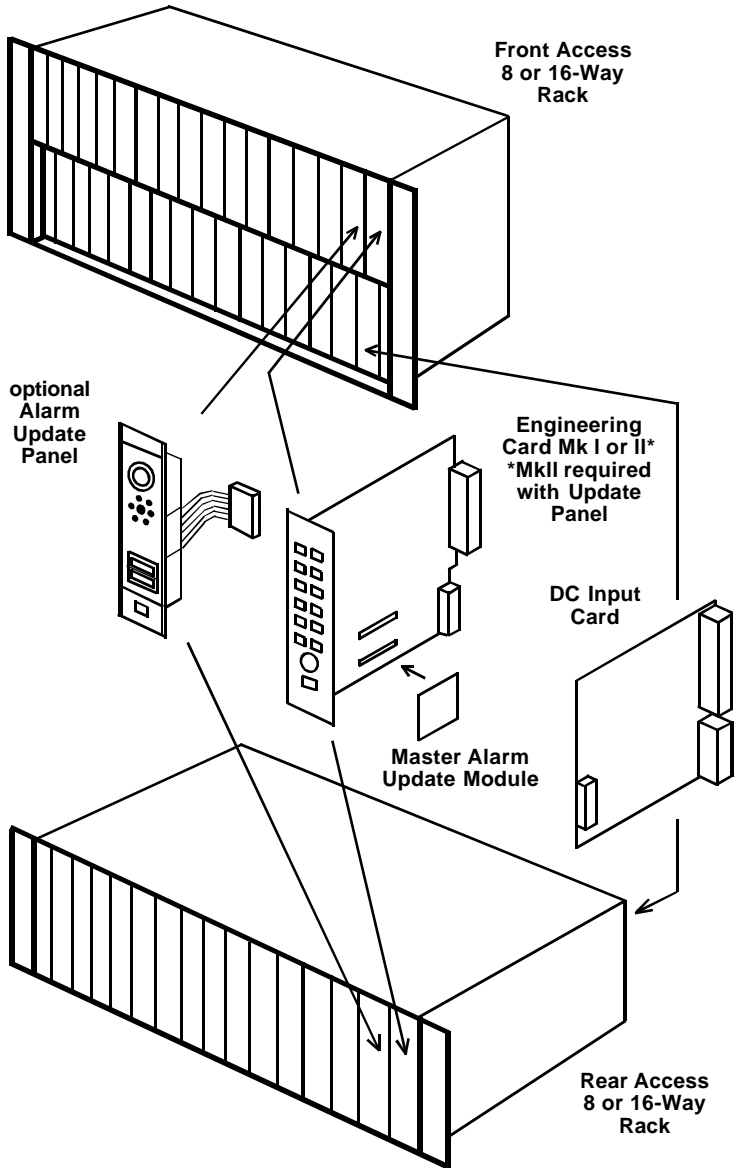

Figure 3 Master Alarm Update Overview

---

## **2. CONTROLS AND FACILITIES**

---

### **2.1 INTRODUCTION**

The 5701 and 5704 Control Systems provide a complete solution for the operational and engineering requirements of a multi-channel gas detection system. Each control card within the rack system provides sensor drive, signal acquisition, gas concentration display and comprehensive alarm facilities for one or more gas sensors.

The Master Alarm Update facility extends the capability of the control system by monitoring the alarm status of every gas sensor connected to the rack in order to provide additional alarm outputs. The additional outputs are activated whenever a new alarm occurs anywhere within the rack, irrespective of any preexisting alarm conditions. These outputs are ideal for controlling audible and visual indicators to draw the operators attention to new gas alarm conditions and to provide a reminder of the continued presence of old alarms.

Two remote type control inputs are provided. One control input allows active alarm update conditions to be acknowledged and the other control input provides a means of performing a simultaneous alarm reset on all channels in the rack.

### **2.2 MASTER ALARM UPDATE MODULE FACILITIES**

#### **2.2.1 Update Outputs**

The Master Alarm Update Module provides two update outputs designated Update 1 and Update 2. The alarm events that are monitored by the update facility to control the outputs are Fault, Inhibit, A1, A2, A3, STEL, LTEL and Rate using information gathered from all cards and/or channels in the rack. Each of the update outputs can be individually configured to operate on one, a subset or all of the alarm events.

---

## 2. CONTROLS AND FACILITIES

---

The operating mode of each output is also configurable for the change in actuation that will result when new alarm events occur, existing alarm events clear or when the update is accepted. The options available in these cases include pulsing, steady, off and no change.

Each output has different electrical characteristics, as follows:

a. Update 1

This is an open collector transistor type output and is useful for switching low voltage low power devices. eg. Lamps.

When the Master Alarm Update Panel is fitted, this output also controls the update panel lamp.

The default configuration for this output is:

- a. pulsing whenever a new alarm occurs, becoming
- b. steady when accepted, if the alarm is still present,

or

off when accepted, if the alarm has cleared.

b. Update 2:

This is a single throw relay output that is set by a hardware link for normally open or closed operation.

This is useful for switching low voltage medium power devices. eg. Sounders.

The default configuration for this output is a steady on whenever a new alarm occurs, switching to off when accepted.

---

## **2. CONTROLS AND FACILITIES**

---

### **2.2.2 Control Inputs**

The Master Alarm Update Module provides two control inputs. Each input can be configured for active high (default) or active low operation. The inputs are as follows:

a. Alarm Update Accept:

This input is associated with the alarm update facility and provides for a remote switch to acknowledge the active alarms.

b. Master Alarm Reset:

This is a remote switch input that provides a facility to allow a general reset of all alarm channels in the rack.

Operating the remote reset will clear all non-active latched alarms and faults as if all RESET/SELECT push-buttons on all the control card front panels had been pressed simultaneously. A master alarm update if active will also be accepted.

## **2.3 MASTER ALARM UPDATE PANEL**































### **2.3.1 Switch Inputs**









The Master Alarm Update Panel provides two push-button switches, conveniently located on the front panel of the rack, to operate the two control inputs of the Master Alarm Update Module. These switches are:

a. Accept Push-button

This button is associated with the alarm update facility and when pressed will acknowledge active alarms.

## 2. CONTROLS AND FACILITIES

Condition	Push-button    Sensor    Lamp    Sounder
Normal condition	   
Sensor 1 in alarm	   
Alarm accept	 Accept
Sensor 1 still in alarm	   
Sensor 2 in alarm	   
Alarm accept	 Accept
Both sensors still in alarm	   
Alarm condition cleared	   
Alarm reset	 Reset
Normal condition	   

<b>Key:</b>			
Push-button:		operated.	
Sensor:	 No alarm condition.	 In alarm condition.	
Lamp:	 Off	 Steady on	 Flashing
Sounder:	 Off	 Steady on	

**Figure 4 Alarm Update Sequence**

---

## 2. CONTROLS AND FACILITIES

---

b. Reset Push-button

This button provides a general reset of all alarm channels in the rack. When pressed the reset will clear all non-active latched alarms and faults as if all RESET/SELECT push-buttons on all the control card front panels had been pressed simultaneously. A master alarm update if active will also be accepted.

### 2.3.2 Audible and Visual Outputs

In order to attract the operators' attention when alarm events occur within the gas monitoring system, the Master Alarm Update Panel provides two conveniently located alarm outputs on the front panel of the rack. These are:

a. Audible Indicator

The audible indication is provided by a loud high pitched sounder which is controlled by the Update 3 alarm function. It can be configured in exactly the same way as the Update 1 and 2 functions.

b. Visual Indicator

The visual indication is provided by a large bright led lamp. The lamp is controlled by the Update 1 function which also controls the open collector transistor output.

---

## 3. INSTALLATION INSTRUCTIONS

---

### WARNING

The Engineering Card and Upgrade Kit are susceptible to damage by static electricity and therefore the appropriate precautions should be taken.

### 3.1 INTRODUCTION

There are two versions of the Engineering Card, Mark I and Mark II.

With the Engineering Card removed from the rack the differences between the two types of Engineering Card can be identified as follows:

- a. Mark I hardware can be identified by the presence of only one 28 pin DIL IC socket on the card pcb. See Figure 5.
- b. Mark II hardware can be identified by the presence of two 28 pin DIL IC sockets and a rectangular cutout near the centre of the card pcb. See Figure 6.

Both the Mark I and Mark II versions of the Engineering Card can be fitted with the Master Alarm Update Kit, for which the installation procedure is identical. The Master Alarm Update Panel can however only be fitted to the Mark II Engineering Card.

A summary of the Master Alarm Update installation procedure is shown below:

- a. Unpack and check equipment.
- b. Remove the Engineering Card from the rack.
- c. Install the Software Expansion EPROM.
- d. Install the Master Alarm Update Module.
- e. Install the Master Alarm Update Panel (if required).
- f. Wire the DC Input Card terminal blocks.
- g. Configure and Commission.

### 3. INSTALLATION INSTRUCTIONS

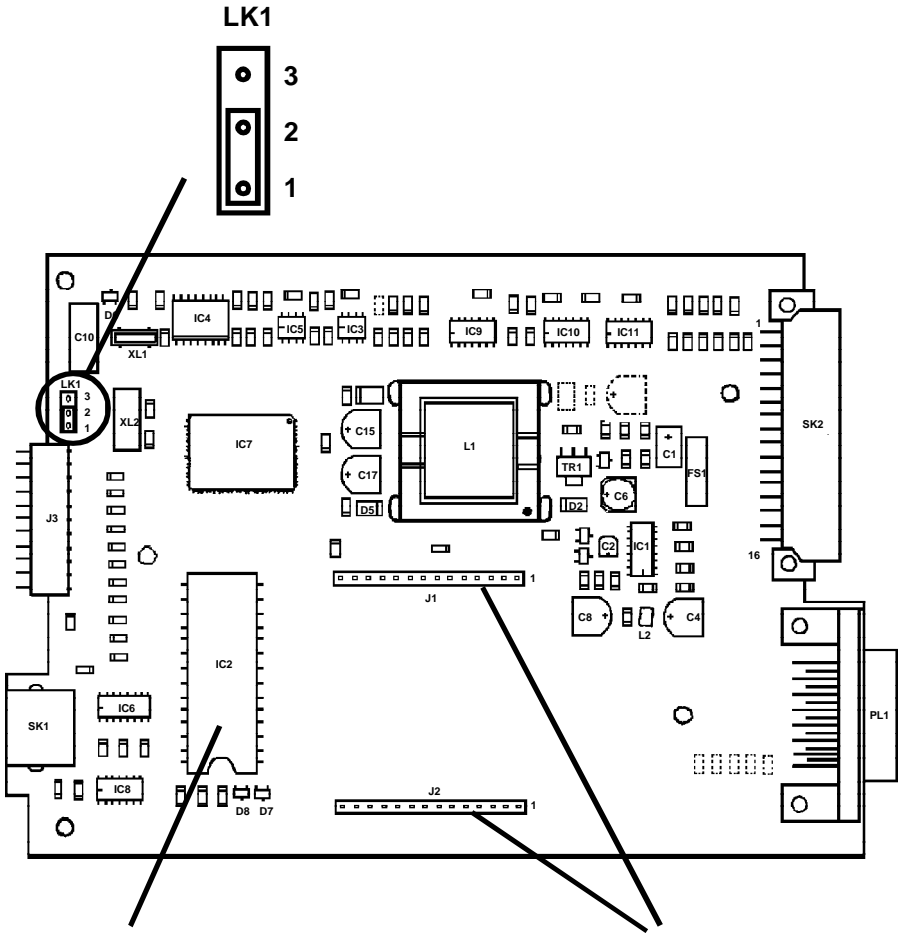

**Insert IC2 EPROM notch downwards**

**When inserting the Master Alarm Update Module, ensure the correct alignment and orientation.**

**Figure 5 System 57- Engineering Card Mark I**

### 3. INSTALLATION INSTRUCTIONS

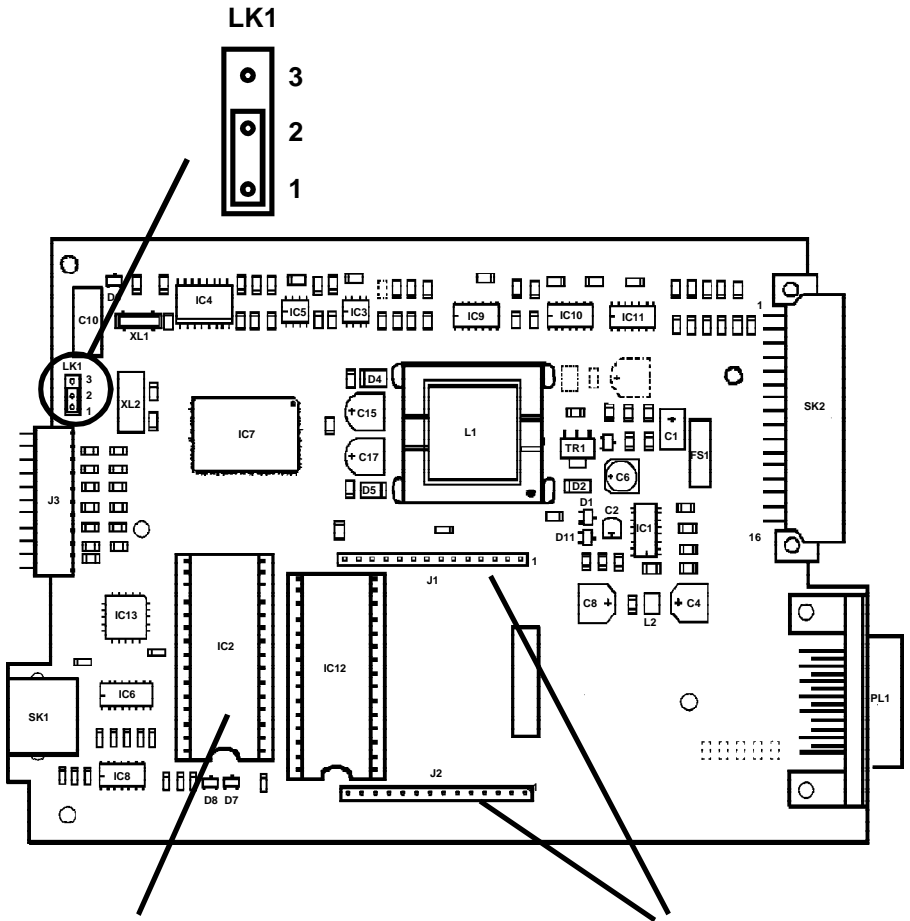

Insert IC2 EPROM  
notch downwards

When inserting the Master Alarm  
Update Module, ensure the correct  
alignment and orientation.

Figure 6 System 57- Engineering Card Mark II

---

## 3. INSTALLATION INSTRUCTIONS

---

After installation is complete perform the commissioning procedures outlined in Section 5.

The following sections of this section provide a detailed explanation of the installation operations.

### 3.2 UNPACKING

On receipt carefully unpack the equipment observing any instructions printed on or contained in the packaging. Check the contents for transit damage and ensure that the following items are present:

For the Master Alarm Update Kit:

- a. Master Alarm Update Module (Part Number 05701-A-0286).
- b. Engineering Card Expansion Option EPROM integrated circuit (Part Number 05701-A-0385).
- c. This User Manual (Part Number 05701-A-5008).

For the optional Master Alarm Update Panel:

- d. Master Alarm Update Panel Assembly (Part Number 05701-A-0339).

### 3.3 INSTALLING THE MASTER ALARM UPDATE KIT

The following procedure applies to both the Mark I and II versions of the Engineering Card.

To install the Master Alarm Update Kit, proceed as follows:

- (1) Isolate the System 57 Rack from all power sources.
- (2) Unscrew the two front panel screws that retain the Engineering Card and, using the extraction tool supplied with the system, pull the Engineering Card from the rack.

---

## 3. INSTALLATION INSTRUCTIONS

---

### WARNING

The Upgrade EPROM can be permanently damaged by incorrect insertion.

- (3) Insert the Software Upgrade EPROM integrated circuit (Part Number 05701-A-0385) into socket IC2 on the Engineering Card. Ensure that pin 1 of the IC is aligned correctly with pin 1 of the socket and that all pins are properly inserted into the socket.
- (4) Using small pliers, or an electrical screwdriver, gently remove the Engineering Card shorting link LK1 from pins 2 and 3 and replace to short pins 1 and 2 (see Figure 5 and 6).
- (5) By default the Update 2 relay output is set for a normally open contact which closes when an update condition is detected. If the Update 2 relay output is required to operate as a normally closed contact which opens when an update condition is detected, LK2 on the Master Alarm Update Module must be reset as follows:
  1. Using small pliers or an electrical screwdriver, gently remove shorting link LK2 on the Master Alarm Update Module.
  2. Replace LK2 to short pins 1 and 2 (see Figure 1).
- (6) Insert the Master Alarm Update Module into socket headers J1 and J2 on the Engineering Card, ensuring that pin 1 of the module pin headers is correctly aligned with pin 1 of the Engineering Card socket headers.
- (7) If it is not required to fit the Master Alarm Update Panel, re-insert the Engineering Card back into the rack, tighten the two front panel securing screws and go to the Section 3.5.

---

## 3. INSTALLATION INSTRUCTIONS

---

### 3.4 INSTALLING THE MASTER ALARM UPDATE PANEL

The Master Alarm Update Panel can only be fitted to the Mark 2 Engineering Card. The Master Alarm Update Module Kit should be installed prior to the Master Alarm Update Panel.

The installation procedure is as follows:

- (1) Isolate the System 57 Rack from all power sources.
- (2) Unscrew the two front panel screws that retain the Engineering Card and, using the extraction tool supplied with the system, pull the Engineering Card from the rack.
- (3) Insert the flying header socket, that is attached to the Master Alarm Update Panel, through the slot located on the back of the Engineering Card and plug the header onto the pins of the Master Alarm Update Module. Ensure that pin 1 of the flying lead, marked by the coloured stripe on one edge of the ribbon cable, corresponds to pin 1 on the Master Alarm Update Module and there are no twists in the cable. See Figure 7.

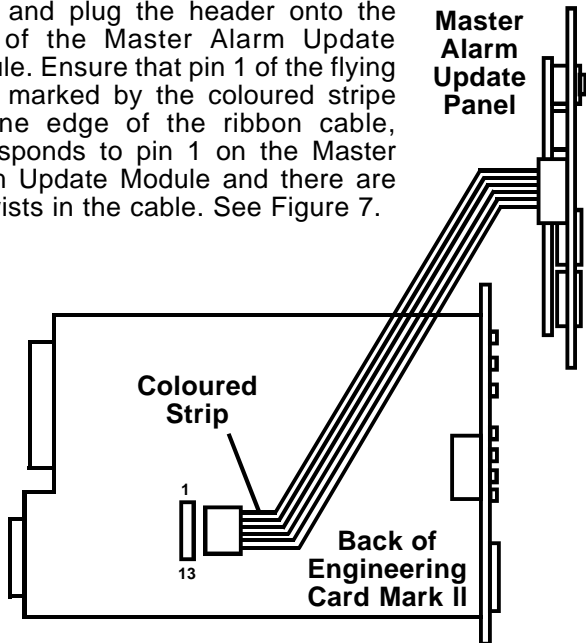

Figure 7 Master Alarm Update Panel Connections

---

## 3. INSTALLATION INSTRUCTIONS

---

- (4) Remove the front panel blanking panel (if fitted) from the slot immediately to the left of the Engineering Card.
- (4) Re-insert the Engineering Card into the most right hand slot in the rack and insert the Update Panel into the slot immediately to the left of the Engineering Card.
- (6) Tighten the two front panel screws that retain the Engineering Card and the two screws that retain the Update Panel.

### 3.5 SYSTEM CONNECTIONS

#### 3.5.1 General

The field connections to the Master Alarm Update Module are made via the auxiliary terminal block (TB2) on the DC Input Card. The terminal block is a two part type to aid the connection of field cables without removing the DC Input Card. The DC Input card terminal connections are shown in Figure 8 and 9.

#### 3.5.2 Cabling

The field terminals of the DC Input Card accept single or multi-stranded wire up to 2.5mm<sup>2</sup> (14 AWG). Cables should be routed carefully to avoid physical and environmental hazards such as mechanical stress and high temperatures.

In order to ensure correct operation and to meet European Standards for RFI and EMC it is recommended that all field cables are screened. The cable screen should be connected to either the ground terminal of the DC Input Card, the cabinet using a suitable metal cable gland or other suitable instrument earth point.

### 3. INSTALLATION INSTRUCTIONS

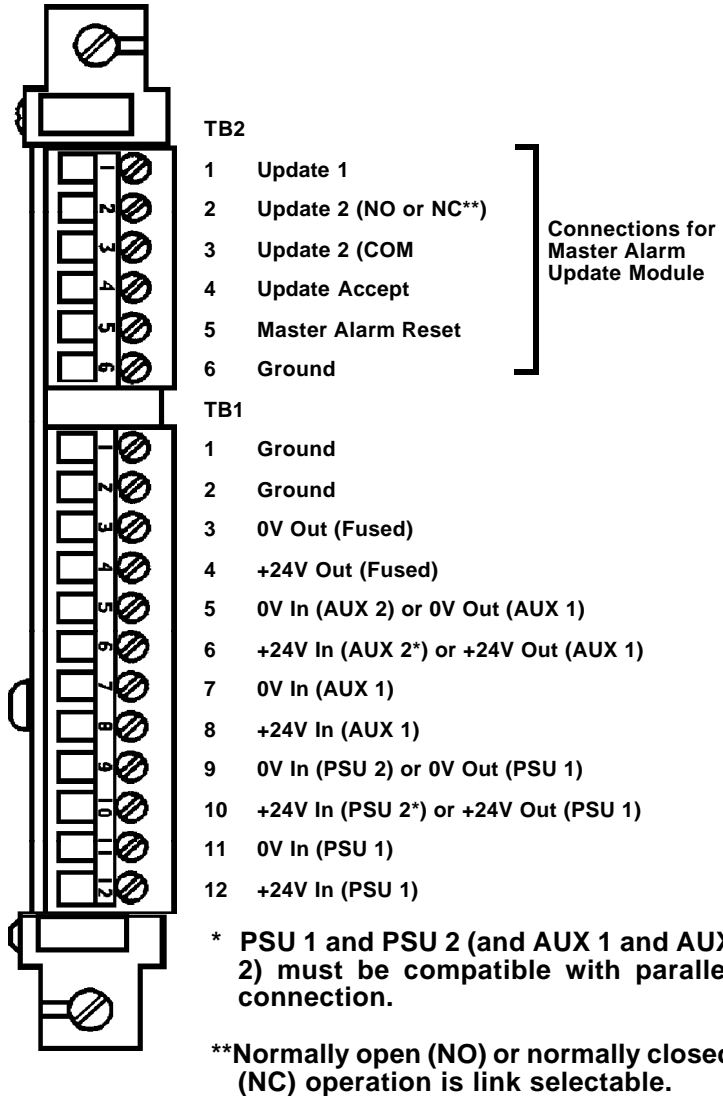
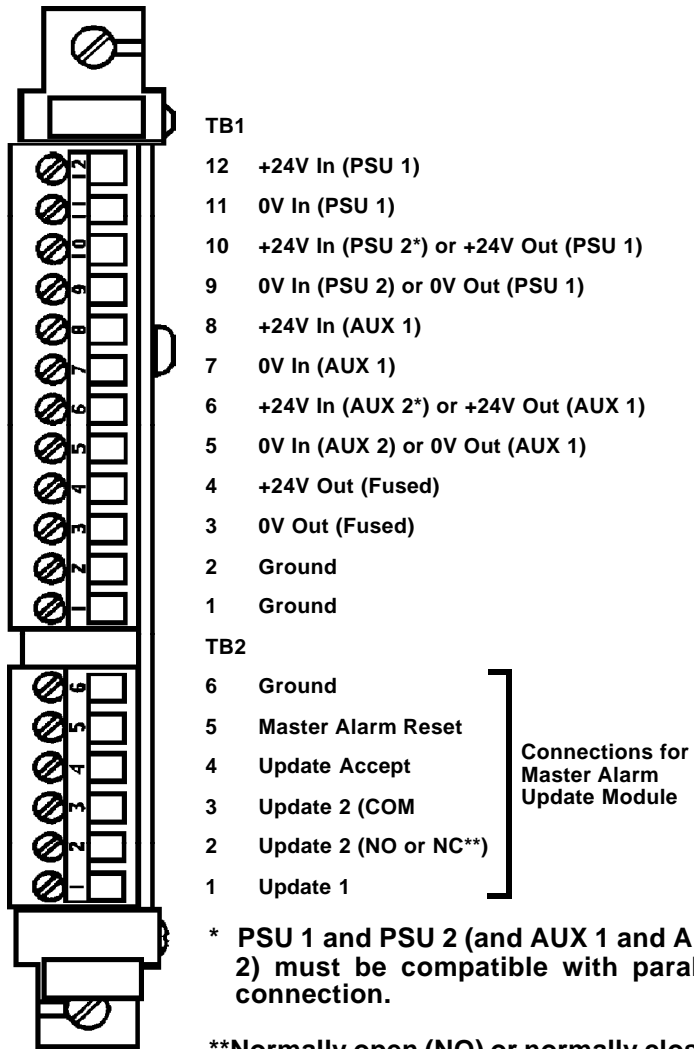

Figure 8 Front Access Connections for DC Input Card and Master Alarm Update Option Module

### 3. INSTALLATION INSTRUCTIONS



\* PSU 1 and PSU 2 (and AUX 1 and AUX 2) must be compatible with parallel connection.

\*\*Normally open (NO) or normally closed (NC) operation is link selectable.

Figure 9 Rear Access Connections for DC Input Card and Master Alarm Update Option Module

---

## 3. INSTALLATION INSTRUCTIONS

---

### 3.5.3 Update 1 - Open Collector Transistor Output

#### CAUTION

The Update 1 output may be permanently damaged if connected to voltages in excess of 40V.

The Update 1 open collector output is suitable for switching low voltage low power devices. eg. Lamps, relays etc. When an update condition is detected the transistor is switched on and current can flow between the Update 1 terminal and the system dc power supply 0V. The transistor outputs is rated at 40V 100mA maximum. Figure 10 shows a wiring example of Update 1 driving a lamp.

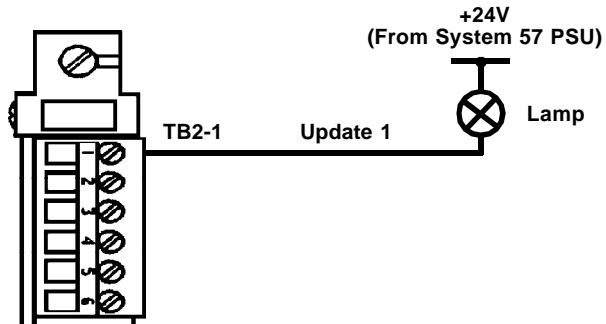

Figure 10 Wiring Example - Update 1 Driving a Lamp

### 3.5.4 Update 2 - Relay Output

#### WARNING

For safety reasons the Update 2 relay output must not be connected to voltages in excess of 40V.

The Update 2 relay output is suitable for switching low voltage medium power devices. eg. Sounders etc. or devices where electrical isolation (not exceeding 50V) is required. When an update condition is detected the relay is energised. The output is link selectable between the normally open and closed contacts of the relay. The relay contacts are rated a 40V 2A maximum.

---

## 3. INSTALLATION INSTRUCTIONS

---

Figure 11 shows a wiring example of Update 2 being used, in the normally open configuration, to operate an external sounder.

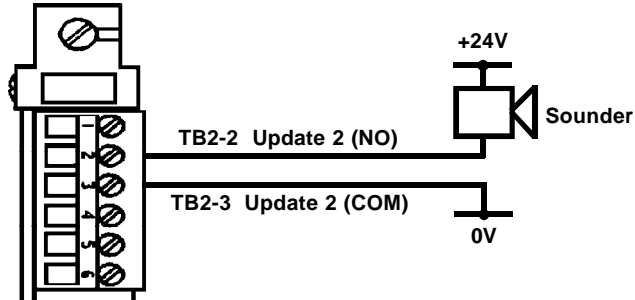

**Figure 11 Wiring Example - Update 2 Operating an External Sounder**

### 3.5.5 Update Accept Input

#### **CAUTION**

Connecting voltages in excess of 40V to the remote input may cause permanent damage to the Master Alarm Update Module.

The Master Alarm Update Accept input can be configured for active high (default) or active low operation. Check the configuration sheet supplied with the system to determine the factory configured operating mode. The operating mode can be reconfigured easily using a computer attached to the Engineering Port. Contact Zellweger Analytics or your local agent for more information.

The switching level of the remote input is approximately +2V with respect to the dc supply 0V. The input requires less than 5mA drive current and irrespective of configuration is internally pulled down to 0V.

Figure 12 shows the connections to the Master Alarm Update Accept control.

---

## 3. INSTALLATION INSTRUCTIONS

---

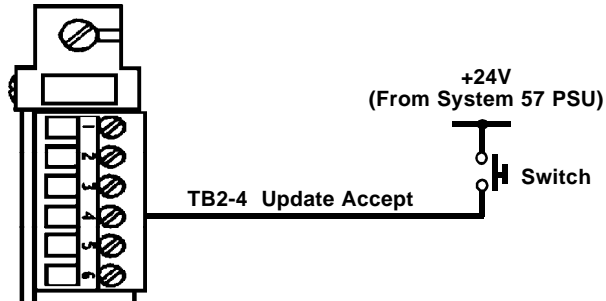

**Figure 12 Update Accept Remote Switch Connection**

An active high remote input may be left unconnected or connected to +24V via a normally open contact. The remote input will operate whenever the contact closes.

An active low remote input may be connected to +24V via a normally closed contact. The remote input will operate whenever the contact opens.

*Note:* 1. Active low operation can not be used if the Update Panel is fitted.

2. Active low inputs must not be left unconnected.

### 3.5.6 Master Alarm Reset Input

#### **CAUTION**

Connecting voltages in excess of 40V to the remote input may cause permanent damage to the Master Alarm Update Module.

The Master Alarm Reset input can be configured for active high (default) or active low operation. Check the configuration sheet supplied with the system to determine the factory configured operating mode. The operating mode can be reconfigured easily using a computer attached to the Engineering Port. Contact Zellweger Analytics or your local agent for more information.

---

### 3. INSTALLATION INSTRUCTIONS

---

The switching level of the remote input is approximately +2V with respect to the dc supply 0V. The input requires less than 5mA drive current and irrespective of configuration is internally pulled down to 0V.

Figure 13 shows the connections to the Master Alarm Update Reset control.

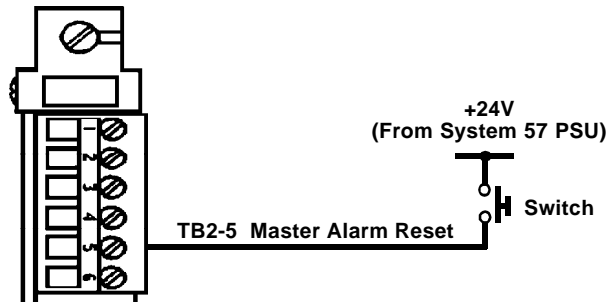

**Figure 13 Master Alarm Reset Remote Switch Connection**

An active high remote input may be left unconnected or can be connected to +24V via a normally open contact. The remote input will operate whenever the contact closes.

An active low remote inputs may be connected to +24V via a normally closed contact. The remote input will operate whenever the contact opens.

*Note:* 1. Active low operation can not be used if the Update Panel is fitted.

2. Active low inputs must not be left unconnected.

---

## **4. CONFIGURING THE UPDATE FUNCTION**

---

### **4.1 GENERAL**

The Master Alarm Update Facility is configured using the Engineering Interface Software (EIS) tool supplied as part of the Engineering Interface Kit. Refer to the user manual supplied with the EIS for detailed instructions on using the software to change the configuration of a rack.

The following sections give a brief summary of the configuration options available for the Master Alarm Update Facility.

### **4.2 UPDATE OUTPUT CONFIGURATION:**

The alarm events monitored by the update facility to control the Update 1, Update 2 and Update 3 outputs are Fault, Inhibit, A1, A2, A3, STEL, LTEL and Rate, using information gathered from all cards and/or channels in the rack. Each of the update outputs can be individually configured to operate on one, a subset or all of the alarm events.

The operating mode of each output is also configurable for the change in actuation that will result when new alarm events occur, existing alarm events clear or when the update is accepted. The options available in these cases include pulsing, steady, off and no change. The pulse rate is also configurable.

### **4.3 CONTROL INPUT CONFIGURATION**

The control inputs Master Alarm Reset and Alarm Update Accept, can be configured for active high (default) or active low operation.

---

## 5. COMMISSIONING AND MAINTENANCE INSTRUCTIONS

---

### IMPORTANT

For completely new System 57 installations that have not previously been tested, the commissioning procedure outlined in the Control System User Manual must be performed fully before attempting to commission the Master Alarm Update Facility.

### 5.1 START UP PROCEDURE

A detailed check of the system wiring should be carried out prior to this start-up procedure.

Start-up the system as follows:

- (1) Ensure that the system power supply is off.
- (2) Reconnect the power supply to the rack and verify that both Engineering Card front panel LED's flash for a short period after which the green POWER ON indicator illuminates continuously.
- (3) Check that the Master Alarm Update outputs are in the non alarm condition.
- (4) Check that after the pre-defined start up inhibit period, typically 30 seconds, the INHIBIT LED on each control card is extinguished, and that there are no alarms or faults signalled on any channel.
- (5) Use the alarm test mode of any one of the control cards in the rack to simulate an alarm condition. (Refer to the Engineer's alarm relay test procedure in the Control System User Manual for more details).
- (6) Check that the Master Alarm Update outputs are actuated in the appropriate state. eg. Pulsing or steady on.
- (7) Activate the Alarm Accept Input and check that the Master Alarm Update outputs change to the required actuation state. eg. Steady or off.

---

## 5. COMMISSIONING AND MAINTENANCE INSTRUCTIONS

---

- (8) Repeat steps 5, 6 and 7 to simulate additional alarms encompassing all levels that are being monitored.
- (9) Clear the simulated alarm set up in step 5.
- (10) Activate the Master Reset Input and check that the Master Alarm Update outputs switch off.

### 5.2 MAINTENANCE

The Master Alarm Update Facility should be tested at regular intervals as outlined in the maintenance procedure given in the Control System User Manual.

### 5.3 FAULT FINDING

The following table identifies common problems and suggests appropriate actions.

Description of Fault	Suggested Action
General Failure.	Check correct orientation and location of update module on Engineering Card.  Check the Enhanced Software EPROM is fitted correctly on Engineering Card and that link LK1 is set accordingly.  Check update module configuration using Engineering Interface Software.
Update Output(s) operate in wrong mode.	Check update module configuration using Engineering Interface Software.
Update 1 Output does not operate.	Check wiring to TB2-1.

---

## 5. COMMISSIONING AND MAINTENANCE INSTRUCTIONS

---

Description of Fault	Suggested Action
Update 2 Output does not operate.	Check wiring to TB2-2 and TB2-3.
Update 2 Output relay contacts operate incorrectly.	Check link LK2 setting on the Master Alarm Update Module.
Control Inputs do not operate.	Check wiring to TB2-4 and TB2-5.  Check input mode configuration using Engineering Interface Software.
Update Panel does not operate.	Check correct orientation and location of update panel header connection to update module.
Update Panel audible output does not operate.	Check update panel configuration using Engineering Interface Software.

---

## 6. OPERATING INSTRUCTIONS

---

The most common use for the Master Alarm Update Facility is to draw the operators attention to new gas alarm conditions within a System 57 rack and to provide a reminder of the continued presence of old alarms.

Generally the update outputs are be connected to give both audible and visual indications whenever a new alarm condition occurs in the rack. After the update alarm has activated the operator can use the Alarm Update Accept input to switch off the audible sounder, however, the visual indication will remain switched on if a gas alarm is still present.

Whenever an update alarm occurs, the operator should examine the alarm status on every card in the rack to assess the severity of the situation and to determine what action if any should be taken. If another alarm occurs a new update condition will be signalled, even if previous alarms have not cleared.

The Master Alarm Reset input can be used as a convenient way to reset of all alarm channels in the rack. Operating the Master Alarm Reset will clear, provided the condition is no longer present, all latched alarms, faults, errors and warning messages as if all RESET/SELECT pushbuttons on all card front panels had been pressed simultaneously. A master alarm update, if active, will also be accepted.

---

## 7. SPECIFICATION

---

### 7.1 ENVIRONMENTAL

Operating Temperature: -5°C to +55°C.

Storage Temperature: -25°C to +55°C.

Humidity: 0 to 90% RH. (Non condensing).

### 7.2 EMC/RFI CONFORMITY

EN50081 Part 1 & Part 2 EMC/RFI (Generic Emission).

EN50082 Part 1 & Part 2 EMC/RFI (Generic Immunity).

*Note: Systems with field connections made via unscreened cable comply with EN50082 Part 1 only.*

### 7.3 MASTER ALARM UPDATE MODULE

**Power Supply:** Powered from Engineering Card.

**Power Consumption:** 0.25W (maximum).

**Weight:** 25g.

**Field Terminals:** 2.5mm<sup>2</sup> (14 AWG) located on DC Input Card.

**Transistor Output:** Update 1.

Modes: Steady or Pulsed (default).

Pulse On/Off Time: Adjustable from 0 to 25.5 seconds in 0.1 second increments.

Maximum Input Voltage: 40V dc.

Maximum Input Current: 100mA.

Saturation Voltage ( $V_{CE}$ ): 3V (maximum).

---

## 7. SPECIFICATION

---

Protection:	Thermal over-current shutdown.
<b>Relay Output:</b>	Update 2.
Modes:	Steady (default) or Pulsed.
Pulse On/Off Time:	Adjustable from 0 to 25.5 seconds in 0.1 second increments.
Contact Type:	Single pole link selectable for normally open or closed operation.
Relay Contact Rating:	2A at 40V dc (non-inductive).
Isolation:	50V relative to system 0V.
<b>Remote Inputs:</b>	Master Alarm Reset and Update Alarm Accept.
Input Threshold:	2V.
Maximum Input Voltage:	40V dc.
Maximum Input Current:	5mA.

### 7.4 MASTER ALARM UPDATE PANEL

<b>Power Supply:</b>	Powered from Engineering Card.
<b>Power Consumption:</b>	0.2W (maximum).
<b>Weight:</b>	35g.
<b>Dimensions:</b>	
Height:	132mm.
Width:	25mm.
Depth:	30mm.

---

## 7. SPECIFICATION

---

<b>Switch Inputs:</b>	Master Reset and Update Alarm Accept.
Contact Type:	Push-button momentary action.
<b>Visible Output:</b>	Update 1 (shared with Update Module).
Modes:	Same as Update 1.
Type:	8mm high intensity red LED lamp.
<b>Audible Output:</b>	Update 3.
Modes:	Steady (default) or Pulsed.
Pulse On/Off Time:	Adjustable from 0 to 25.5 seconds in 0.1 second increments.
Type:	Piezo electric buzzer.
Nominal Frequency:	2khz
Sound Level:	85dB at 100mm.

---

## **USER NOTES**

---

---

## **USER NOTES**

---

**Find out more**

[www.honeywellanalytics.com](http://www.honeywellanalytics.com)

**Customer business centre**

**Europe and the rest of the world**

Honeywell Analytics AG

Wilstrasse 11-U11

CH-8610 Uster

Switzerland

Tel: +41 (0)1 943 4300

Fax: +41 (0)1 943 4398

[sales@honeywellanalytics.co.uk](mailto:sales@honeywellanalytics.co.uk)

**Customer business center**

**Americas**

Honeywell Analytics Inc.

400 Sawgrass Corporate Pkwy

Suite 100

Sunrise, FL 33325

USA

Tel: +1 954 514 2700

Toll free: +1 800 538 0363

Fax: +1 954 514 2784

[sales@honeywellanalytics.com](mailto:sales@honeywellanalytics.com)

[www.honeywell.com](http://www.honeywell.com)



Issue 1 12/2005  
H\_MAN0505.PM6\_V1  
05701-M-5008  
© 2005 Honeywell Analytics